

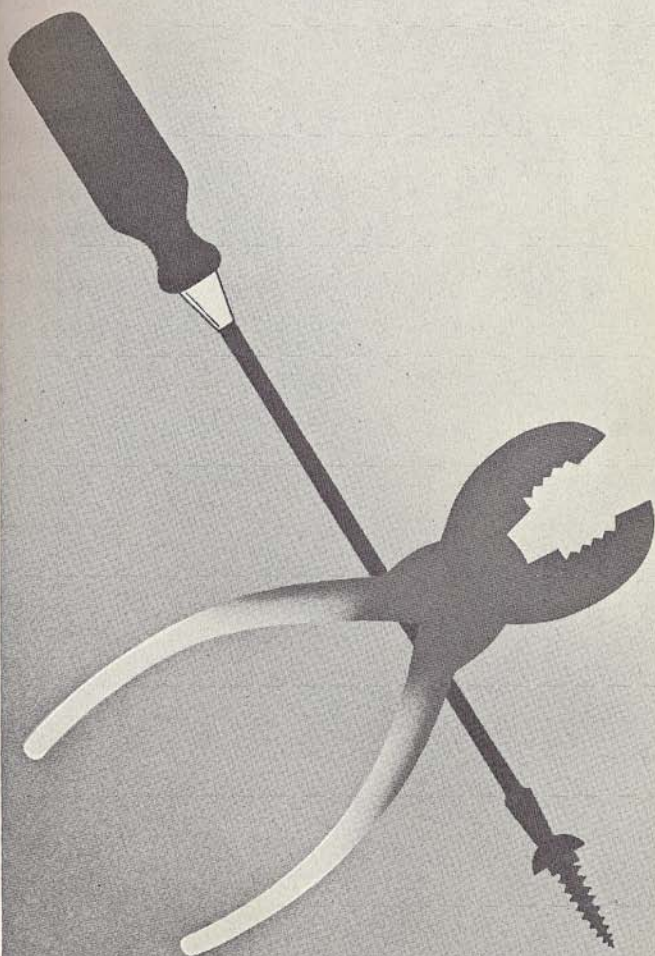

# WINDOWS AND VENTILATORS

# SERVICE MANUAL



## YOU HAVE MADE A GOOD CHOICE

The Hehr windows or vents in your mobile home or recreational vehicle are made to last the life of the unit. But, there isn't a mechanical thing made that doesn't require some service attention now and then; even your Rolls-Royce needs an occasional tune-up or tire change. That's why we published this booklet, we don't expect you to read it, just file it where you can find it. When there is some kind of trouble with a window or a ventilator you can turn direct to the proper page and read only that portion which deals with the answers to your particular problem on your specific unit.

# INDEX

How to Order Storm Sash .....	1
Installation and Service of the following Hehr Windows:	
Hall-Mark Stationary (Model 1103) .....	2
Outside Mounted Storm Sash for Model 1103 .....	2
Inner Frame and Storm Sash for Model 1103 .....	2
Hall-Mark Jalousie Windows (1600 Series) .....	3
Hall-Mark Jalousie Windows (2700 Series) .....	4
Hall-Mark Lite-Aire (Wide Louver) Windows (2400 Series) .....	5
Hall-Mark Multi-Tork Windows (3500 and 3600 Series) .....	6
Inner Frame and Storm Sash for 2700, 2400, 3500, and 3600 Series Windows .....	7
Hall-Mark '17' Opening and Combination Windows .....	7
Outside Mounted Storm Sash for '17' Opening and Combination Windows .....	8
Hall-Mark '17' Stationary Windows (Models 1717, 1720 and 1790) .....	9
Outside Mounted Storm Sash for 1717, 1720 and 1790 Stationary Windows .....	9
Inner Frame and Storm Sash for 1717 Stationary Windows .....	9
Hall-Mark Sliding Windows (2500 Series) .....	10
Inner Frame and Storm Sash for 2500 Series Sliding Windows .....	10
Standard Opening Windows and Vent Windows .....	11
Standard Combination Windows .....	12
Care of Plexi-Glazed Windows .....	13
Installation and Service of the Following Hehr Ventilators:	
No-Draft Roof Vents .....	14
Power Kit for No-Draft Vents .....	14
No-Draft Power Vents .....	15
Standard Roof Vents .....	16
Model 9108 Jr. Roof Vents .....	16
Stove Hoods with Blower and Light .....	17
Sidewall Power Ventilators .....	18
How to Select Replacement Motors and Fans .....	18
Replacement Parts for:	
1600 Series Jalousie Windows .....	19
2700 Series Jalousie Windows .....	19
2400 Series Wide Louver Windows .....	20
3500 and 3600 Series Multi-Tork Windows .....	21
Hall-Mark '17' Stationary Windows .....	22
2500 Series Sliding Windows .....	23
Hall-Mark Storm Sash .....	23
Standard Opening Windows (Lever Operated) .....	24
(Gear Operated) .....	25
LPG Compartments .....	26
Baggage Door Lock .....	26
No-Draft Roof Vents (14 x 14) (17 x 17) .....	27
Standard Roof Vents .....	28
9108 Jr. Vent .....	28
Stove Hoods .....	29
Sidewall Vents .....	30
Trunk Door .....	31
Control of Condensation .....	32

## HOW TO ORDER STORM SASH

Three types of storm sash — outside mounted (Type A), inside mounted (Type B), and inner frame mounted (Type C) — are available for Hehr windows. Several types may be used on some window models, but other models are restricted to one type. The Hehr window model numbers, the available storm sash, and how to order it, are given in the following.

**Type 'A'**  
Outside mounted  
(circle shows cross-section)

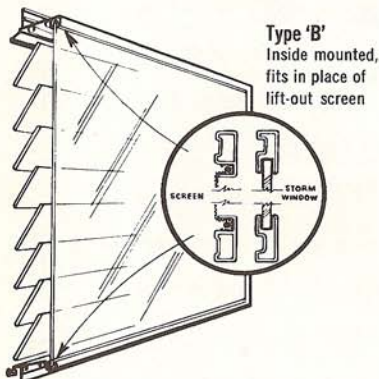
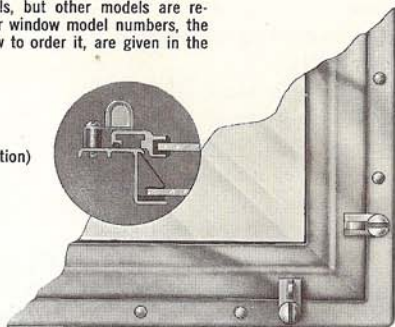

**Type 'B'**  
Inside mounted,  
fits in place of  
lift-out screen

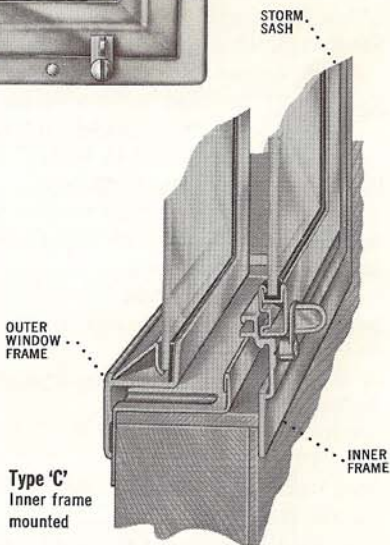

**Type 'C'**  
Inner frame  
mounted

### HALL-MARK STATIONARY WINDOWS — Model 1103 (without mullions) (pg. 2)

Outside mounted storm sash, Type A (pg. 2):

Give overall outside height and width.

Inner frame and storm sash, Type C (pg. 2):

Give model number stamped on inner frame. If no number, give overall height and width of inner frame.

### HALL-MARK 1600 SERIES JALOUSIE WINDOWS (pg. 3)

### HALL-MARK 2700 SERIES JALOUSIE WINDOWS (pg. 4)

### HALL-MARK 2400 SERIES LITE-AIRE (WIDE LOUVER) WINDOWS (pg. 5)

Inside mounted storm sash, Type B (pgs. 3, 4, 5 respectively):

Give model number located on the outside mounting flange of the side piece with the operator.

Inner frame storm sash, Type C, for 2700 and 2400 series only (pg. 7):

Give numbers stamped on the inner frame. If no number, give overall height and width of inner frame.

Also give model number of the window.

### HALL-MARK 3500 and 3600 SERIES MULTI-TORK WINDOWS (pg. 6)

Inside mounted storm sash, Type B (pg. 6):

Give model number located on the inside surface of the bottom piece under the torque tube.

Inner frame Storm Sash, Type C (pg. 7):

Give numbers stamped on the inner frame. If no number, give overall height and width of inner frame.

Also give model number of window.

### HALL-MARK 17 WINDOWS, Single pane, Tiered, Combination (pg. 7)

Outside mounted storm sash, Type A (pg. 8):

Give model number stamped on outside of window on bottom mounting flange.

### HALL-MARK 17 STATIONARY WINDOWS — Models 1717, 1720 and 1790 (pg. 9)

Outside mounted storm sash, Type A (pg. 9):

Give model number stamped on outside bottom mounting flange.

Inner frame storm sash, Type C (pg. 9):

Give model number stamped on inner frame. If no number, give overall height and width of inner frame.

### HALL-MARK SLIDING WINDOWS 2500 SERIES (pg. 10)

Inner frame storm sash, Type C (pg. 10):

Give model number stamped on inner frame. If no number, give overall height and width of inner frame.

Also give model number of window, located on the outside mounting flange.

## HALL-MARK STATIONARY WINDOWS—Model 1103 (See Also 1717—1720—1790)

### INSTALLATION INSTRUCTIONS:

#### HOLE CUT-OUT

Be sure that the hole cut-out is square and that the proper clearance has been allowed.

#### CAULKING

We recommend a non-hardening type of caulking. Apply at least  $\frac{1}{8}$ " caulking around the mounting flange.

#### INSTALLATION

Install  $\frac{1}{8}$ " shims at the bottom and one side of the hole cut-out. This will center the window in the hole providing the hole was cut as required. Use #8 x  $\frac{3}{4}$ " type "A" cad-plated steel sheet metal screws for fastening the window to the trailer. After the window has been fastened securely to the trailer wall, remove the shims and finish fastening the window. Remove the excess caulking from around the window and apply a non-drying liquid sealer around the edge of the window where it meets the trailer wall.

### SERVICE INSTRUCTIONS:

#### REGLAZING PROCEDURE

##### REMOVING BROKEN GLASS

Remove the mitered glass clips first, then the straight. To remove the clips, insert a hook type paint scraper or similar tool under the edge of the clip next to glass, starting at one end and with a slight rocking action work the clip out. Remove broken pieces of glass and clean rubber seal; be sure there are no small pieces of glass imbedded in the rubber seal.

#### STORM SASH, OUTSIDE MOUNTED—Model 1103 Stationary Windows

### INSTALLATION INSTRUCTIONS:

Remove the eight corner mounting screws from the stationary window and replace them with the clips and screws provided. On each side, measure the distance between the corner clips. If the distance between two corner clips is greater than 20", add sufficient clips to make equal spaces of not more than 18". Use the window mounting holes for fastening the clips as before.

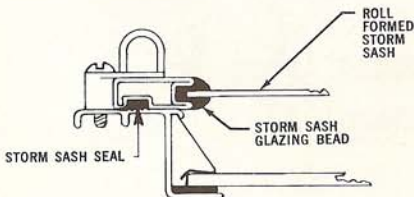

#### INNER FRAME AND STORM SASH—Model 1103 Hall-Mark Stationary Windows

(Can be used only where wall thickness is a minimum of  $1\frac{1}{8}$  inches)

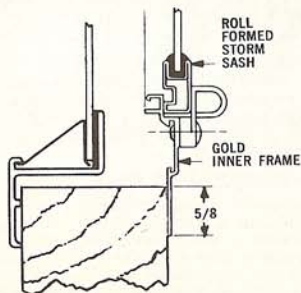
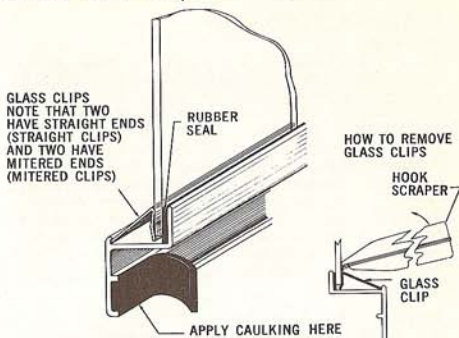

FIG. 1



APPLY CAULKING HERE

#### INSTALLING NEW GLASS

If the rubber has been broken or damaged in removing the old glass, obtain a new seal from your supply store or in case of emergency use electricians' tape laminated to approximately  $\frac{1}{16}$ " thick. Cut your glass (DSB), leaving approximately  $\frac{1}{8}$ " between glass and frame when in place. Apply a rubber cement or other adhesive to the rubber seal before placing the glass in the frame. Center the glass and install clips, both straight clips first then the mitered clips, by placing the top edge of the clip in place and starting at one end, work the bottom in until the lip on the clip is hooked over the edge of the glass. Trim rubber seal with a razor blade if it protrudes beyond the frame after you have completed the above operations.

### ROLL FORMED STORM SASH REGLAZING INSTRUCTIONS:

#### GLASS SIZE

Before disassembling the storm sash, measure the overall size of the frame. Subtract from these dimensions one inch. This will give you the cut size for the new glass.

#### DISASSEMBLY OF THE FRAME

To remove the frame pieces from the glass, place a block of wood against the inner side of the frame and tap against it. Start at one end and work back and forth across the part until it comes off the glass. Repeat this procedure on the other three sides.

#### REASSEMBLY OF THE FRAME

Replace the "U" channel glazing bead on the new glass. Center a part (without the corners) on the glass and tap against it down evenly until it "bottoms." Leave the corners for the two parts installed last. Next, install the side opposite the one you have installed. Insert the corners in the remaining two sides and install them. This completes the assembly of the storm sash.

### INSTALLATION INSTRUCTIONS:

#### INSTALLATION OF GOLD INNER FRAME

At the bottom and one side of the window, mark the inner wall  $\frac{3}{8}$ " from the edge of the hole cut-out (Fig. 1). Place the edges of the inner frame against the marks and fasten the bottom side. Use #6 x  $\frac{3}{4}$ " sheet metal or wood screw for fastening. After fastening the bottom, square the frame using a carpenter's square or insert the storm sash as a guide and install the screws in the rest of the frame. On gold inner frame, storm sash clips are factory installed. Insert the storm sash in the frame and turn the clips to secure the storm sash.

### STORM SASH REGLAZING INSTRUCTIONS

#### ROLL FORMED STORM SASH

See above

## HALL-MARK (1600 SERIES) JALOUSIE WINDOWS

### INSTALLATION INSTRUCTIONS:

#### CAULKING

Apply mastic all around, on the back side of the window mounting flange. Enough to be sure it will fill in any irregularity in the outside surface of the trailer.

#### INSTALLATION

Be sure the opening is square and the window is placed into it properly, leaving clearance all around it. Do not install the window on a curved or uneven surface. It may be necessary to shim the window to keep the frame straight for proper performance. Install the screws at the top of the window first. If the window is centered and square in the opening, install the remaining screws. We suggest #8 x 1 1/4" type "A," with a binder head, aluminum or cadmium plated steel sheet metal screws.

#### INSTALLING THE OPERATOR

With louvers in open position, insert the operator's link boss into the hole in the pivot bar and line up the screw holes and fasten the operator to the frame with the screws furnished. Tighten the mounting screws.

#### INSTALLING LOUVER GLASS

Pivot the glass retainer clips on both sides to open position. Insert the glass from the outside of the window, straight into them. Insert the rubber pads between the glass and the half round tab on the clip and compress the pad between the tab and the glass, using a pair of pliers.

### SERVICE INSTRUCTIONS:

#### RESCREENING

Remove the spline from the groove and pull the screen out. It is advisable, before rescreening the frame, to make some provision to keep it square, its sides parallel and prevent the tension of the screen from bowing them inward. This can be done by nailing (4) pieces of wood to a flat surface in a manner which will permit you to slip the frame over the outside of them. The wood will then act as spreaders, keeping the frame square and from bowing in while the screen is being splined into the groove. Measure the distance between the spline grooves and add about 2" to the height and width for the screen material size needed, allowing for trimming after the screen has been splined in. For best results, use fiberglass screening material. Lay the new screen over the frame and leave about 1" overlapping the spline grooves. Start at one corner and spline the screen into the groove with a blunt screwdriver, a narrow roller or similar tool. Hold a tight tension on the screen in the direction you are working. Follow this procedure working around the frame, finishing at the corner you started. Check the screen frame to make sure it is still square and the sides are parallel. Trim the excess screen with a razor blade or sharp knife.

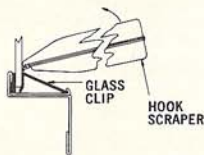

**REMOVAL OF BROKEN GLASS AND REGLAZING OF THE STATIONARY PORTION OF THE COMBINATION JALOUSIES**  
Using a hook scraper, remove the metal glazing beads by prying them away from the glass. Start at one end of the bead and work to the other end; remove the mitered ones first (usually vertical). In removing broken glass, if the glass does not release from the tape, apply a little heat. If the tape tears, remove all of it and replace with new 009-107 (black) or a suitable glazing putty. Butt the tape tightly at the corners; do not overlap. If using glazing putty, apply it 1/8" thick. Cut the new glass 1/8" smaller in size than the portion of the frame thru which it fits or, if possible, measure the old glass. Place the glass in the frame with even clearance-all around. Re-install the glazing beads as they were before their removal.

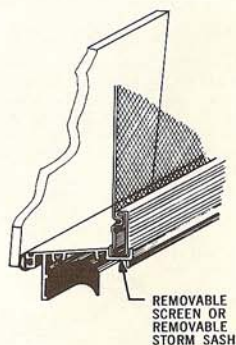
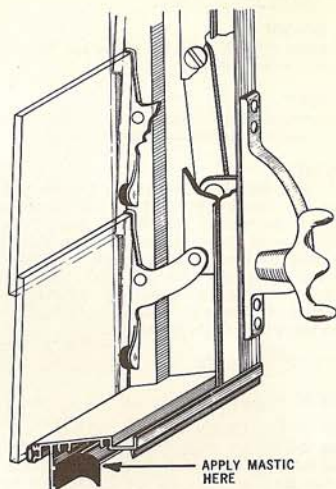

### ROLL FORMED STORM SASH REGLAZING INSTRUCTIONS:

#### GLASS SIZE

Before disassembling the storm sash, measure the overall size of the frame. Subtract from these dimensions one inch. This will give you the cut size for the new glass.

#### DISASSEMBLY OF THE FRAME

To remove the frame pieces from the glass, place a block of wood against the inner side of the frame and tap against it. Start at one end and work back and forth across the part until it comes off the glass. Repeat this procedure on the other three sides.

#### REASSEMBLY OF THE FRAME

Replace the "U" channel glazing bead on the new glass. Center a part (without the corners) on the glass and tap it down evenly until it "bottoms." Leave the corners for the two parts installed last. Next, install the side opposite the one you have installed. Insert the corners in the remaining two sides and install them. This completes the assembly of the storm sash.

## HALL-MARK (2700 SERIES) JALOUSIE WINDOWS

### INSTALLATION INSTRUCTIONS:

#### SOLE CUT-OUT

The opening in which the window is to be installed must be of adequate size to give proper clearance. The top, bottom and sides of the opening must be square to each other and level (not racked or curved).

#### CAULKING

Apply a suitable non-hardening type caulking to the back side of the mounting flange, keeping it close to the outside edge of the window. Apply enough to be sure it will fill in any irregularities in the outside surface around the hole in which the window is being installed.

#### INSTALLATION

When installing the window be sure vents are in closed position, this helps keep the window squared during installation. The window should be centered in the hole, leaving approximately  $\frac{1}{8}$ " clearance all around the inside portion (use shims if necessary), this clearance will permit the use of a metal garnish. Suggested installation screws are #8 x  $1\frac{1}{4}$ " Type "A," binder head, aluminum or steel cadmium plated sheet metal screws. Install these screws straight into the wall, starting at the top of the window, after the first few screws are installed, check to be sure the window is still centered and square in the hole then install and tighten the remaining screws. Remove the excess caulking from around the outer edge of the window and apply a semi-liquid sealer all around the outer edge.

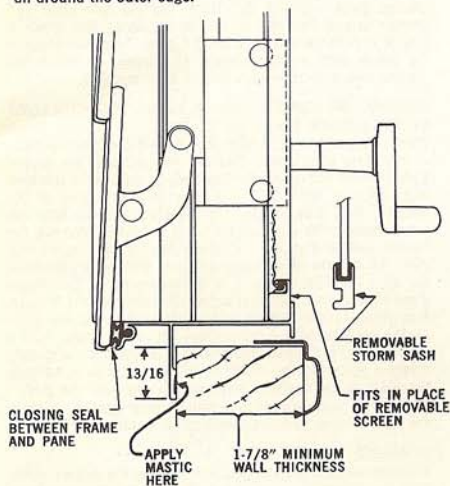

being splined into the groove. Measure the distance between the spline grooves and add about 2" to the height and width for the screen material size needed, allowing for trimming after the screen has been splined in. For best results, use fiberglass screening material. Lay the new screen over the frame and leave about 1" overlapping the spline grooves. Start at one corner and spline the screen into the groove with a blunt screwdriver, a narrow roller or similar tool. Hold a tight tension on the screen in the direction you are working. Follow this procedure working around the frame, finishing at the corner you started. Check the screen frame to make sure it is still square and the sides are parallel. Trim the excess screen with a razor blade or sharp knife.

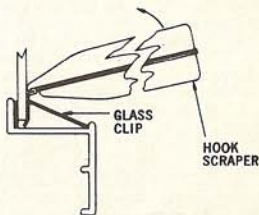

#### REMOVAL OF BROKEN GLASS AND REGLAZING OF THE STATIONARY PORTION OF THE COMBINATION JALOUSIES

Using a hook scraper, remove the metal glazing beads by prying them away from the glass. Starting at one end of the bead and work your way to the other end of it, remove the mitered ones first (usually vertical). In removing the broken glass, if it doesn't release from the tape, apply a little heat. If the tape tears, remove all of it and replace it with new 009-107 (black) or a suitable glazing putty. Butt the tape tightly at the corners, do not overlap. If using glazing putty, apply it  $\frac{1}{4}$ " thick. Cut the new glass  $\frac{1}{8}$ " smaller in size than the portion of the frame thru which it fits, or if possible, measure the old glass. Place the glass in the frame with even clearance all around. Re-install the glazing beads as they were before their removal.

#### INSTALLING LOUVER GLASS

Pivot the glass retainer clips to open position. Insert the glass from the inside of the window straight into the clips until it snaps into place. Caution: If your windows have inner frame garnish, remove the inner frame before attempting to install glass.

#### REMOVING THE OPERATOR

With the louvers in open position, remove the screws which hold the operator to the frame. Remove the "E" ring from link boss. The link and operator may now be lifted from the pivot bar. To re-install the operator, reverse the procedure.

#### REGLAZING INSTRUCTIONS:

##### ROLL FORMED STORM SASH

##### GLASS SIZE

Before disassembling the storm sash, measure the overall size of the frame. Subtract from these dimensions one inch. This will give you the cut size for the new glass.

##### DISASSEMBLY OF THE FRAME

To remove the frame pieces from the glass, place a block of wood against the inner side of the frame and tap against it. Start at one end and work back and forth across the part until it comes off the glass. Repeat this procedure on the other three sides.

##### RE-ASSEMBLY OF THE FRAME

Replace the "U" channel glazing bead on the new glass. Center a part (without the corners) on the glass and tap it down evenly until it "bottoms." Leave the corners for the two parts installed last. Next, install the side opposite the one you have installed. Insert the corners in the remaining two sides and install them. This completes the assembly of the storm sash.

### SERVICE INSTRUCTIONS:

#### SCREEN FRAME AND STORM SASH REMOVAL

Push the screen frame or storm sash assembly up into the top portion of the window, until the bottom of the frame is above the lip of the bottom piece of the window. Pull the bottom of the frame in, past the window bottom piece lip and lower the frame to where the top portion will clear the lip on the top piece and can be pulled out.

#### REMOVING A SCREEN

Remove the spline from the groove and pull the screen out. If inner frame is screened, first remove it from the interior wall.

#### INSTALLING THE SCREEN

It is advisable, before rescreening the frame, to make some provision to keep it square, its sides parallel and prevent the tension of the screen from bowing them inward. This can be done by nailing four (4) pieces of wood to a flat surface in a manner which will permit you to slip the frame over the outside of them. The wood will then act as spreaders, keeping the frame square and from bowing in while the screen is

## HALL-MARK LITE-AIRE WINDOWS (2400 SERIES)

### INSTALLATION INSTRUCTIONS:

#### SOLE CUT-OUT

The opening in which the window is to be installed must be of adequate size to give proper clearance. The top, bottom and sides of the opening must be square to each other and level.

#### CAULKING

Apply a suitable non-hardening type caulking to the back side of the mounting flange, keeping it close to the outside edge of the window. Apply enough to be sure it will fill in any irregularities in the outside surface around the hole which the window is being installed.

#### INSTALLATION

When installing the window be sure vents are in closed position, this helps keep the window squared during installation. The window should be centered in the hole, leaving approximately  $\frac{1}{8}$ " clearance all around the inside portion (use shims if necessary), this clearance will permit the use of a metal garnish. Suggested installation screws are #8 x  $1\frac{1}{4}$ " Type "A," binder head, aluminum or steel cadmium plated sheet metal screws. Install these screws straight into the wall, starting at the top of the window, after the first few screws are installed, check to be sure the window is still centered and square in the hole then install and tighten the remaining screws. Remove the excess caulking from around the outer edge of the window and apply a semi-liquid sealer all around the outer edge.

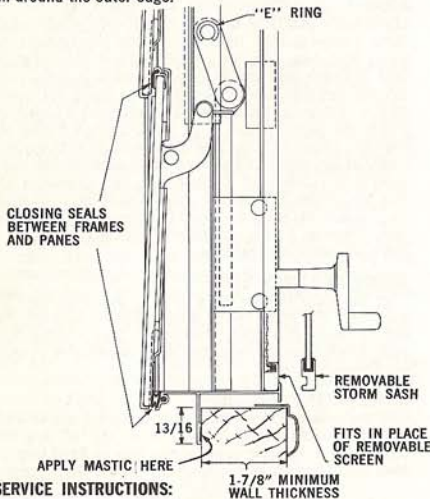

#### SERVICE INSTRUCTIONS:

##### SCREEN FRAME AND STORM SASH REMOVAL

Push the screen frame or storm sash assembly up into the top portion of the window, until the bottom of the frame is above the lip of the bottom piece of the window. Pull the bottom of the frame in, past the window bottom piece lip and lower the frame to where the top portion will clear the lip on the top piece and can be pulled out.

##### REMOVING A SCREEN

Remove the spline from the groove and pull the screen out. If inner frame is screened, first remove it from the interior wall.

##### INSTALLING THE SCREEN

It is advisable, before rescreening the frame, to make some provision to keep it square, its sides parallel and prevent the tension of the screen from bowing them inward. This can be done by nailing four (4) pieces of wood to a flat surface in a manner which will permit you to slip the frame over the outside of them. The wood will then act as spreaders, keeping the frame square and from bowing in while the screen is being splined into the groove. Measure the distance between the spline grooves and add about 2" to the height and width

for the screen material size needed, allowing for trimming after the screen has been splined in. For best results, use fiberglass screening material. Lay the new screen over the frame and leave about 1" overlapping the spline grooves. Start at one corner and spline the screen into the groove with a blunt screwdriver, a narrow roller or similar tool. Hold a tight tension on the screen in the direction you are working. Follow this procedure working around the frame, finishing at the corner you started. Check the screen frame to make sure it is still square and the sides are parallel. Trim the excess screen with a razor blade or sharp knife.



##### REMOVAL OF BROKEN GLASS AND REGLAZING OF THE STATIONARY PORTION OF THE COMBINATION JALOUSIES

Using a hook scraper remove the metal glazing beads by prying them away from the glass. Starting at one end of the bead and work your way to the other end of it, remove the mitered ones first (usually vertical). In removing the broken glass, if it doesn't release from the tape, apply a little heat. If the tape tears, remove all of it and replace it with new 009-107 (black) or a suitable glazing putty. Butt the tape tightly at the corners, do not overlap. If using glazing putty, apply it  $\frac{1}{16}$ " thick. Cut the new glass  $\frac{1}{8}$ " smaller in size than the portion of the frame thru which it fits, or if possible, measure the old glass. Place the glass in the frame with even clearance all around. Re-install the glazing beads as they were before their removal.

##### REMOVAL OF BROKEN LOUVER GLASS AND REGLAZING OF THE LOUVER GLASS

With a screwdriver or similar tool, spread the inside portion of the glass clips where they are crimped over the rubber pads. Spread the clips until the pads can easily be removed and replaced. With the same tool, on the outside of the window, work it in between the glass and the clip until the bond between the clip and the glass is broken. Remove the broken glass and scrape the excess glue from inside the clip. With the louvers in the open position, slide new glass into the clips from the inside. It is recommended to obtain new glass with the channel seal across the top from the factory. Run some glass to metal cement between the clip and glass on the outside, before reinstalling the rubber pads. With a pair of long nose pliers or similar tool, squeeze the originally crimped portion of the clip tight on the rubber pads, causing the glass to be captured between the clip and the pad.

Caution: If your window has inner frame garnish, remove the inner frame before attempting to install glass.

##### REMOVING THE OPERATOR

With the louvers in open position, remove the screws which hold the operator to the frame. Remove the "E" ring from link boss. The link and operator may now be lifted from the pivot bar. To re-install the operator, reverse the procedure.

##### REGLAZING INSTRUCTIONS: ROLL FORMED STORM SASH GLASS SIZE

Before disassembling the storm sash, measure the overall size of the frame. Subtract from these dimensions one inch. This will give you the cut size for the new glass.

##### DISASSEMBLY OF THE FRAME

To remove the frame pieces from the glass, place a block of wood against the inner side of the frame and tap against it. Start at one end and work back and forth across the part until it comes off the glass. Repeat this procedure on the other three sides.

##### RE-ASSEMBLY OF THE FRAME

Replace the "U" channel glazing bead on the new glass. Center a part (without the corners) on the glass and tap it down evenly until it "bottoms." Leave the corners for the two parts installed last. Next, install the side opposite the one you have installed. Insert the corners in the remaining two sides and install them. This completes the assembly of the storm sash.



## HALL-MARK MULTI-TORK WINDOWS (3500 and 3600 SERIES)

### INSTALLATION INSTRUCTIONS:

#### HOLE CUT-OUT

The opening in which the window is to be installed must be of adequate size to give proper clearance (approx.  $\frac{1}{8}$ " on all sides). The opening must be square and level.

#### CAULKING

Apply a suitable non-hardening type caulking to the back side of the mounting flange, keeping it close to the outside edge of the window. Apply enough to be sure it will fill in any irregularities in the outside surface around the hole in which the window is being installed.

#### INSTALLATION

When installing the window, be sure the vents are in closed position to keep the shipping clips in place. This keeps the window squared during installation. The shipping clips should not be removed until after the window is completely installed. The window should be centered in the hole, leaving approx.  $\frac{1}{8}$ " clearance all around the inside portion (use shims if necessary). This clearance will permit the use of garnish (interior trim). Suggested installation screws are #8 x  $1\frac{1}{4}$ " Type "A" binder head aluminum or steel cadmium plated sheet metal screws. Install these screws straight into the wall, starting at the top (at or near center) of the window. After the first few screws are installed, check to be sure the window is still centered and squared in the hole. Then install and tighten the remaining screws. Remove the excess caulking from around the outer edge of the window and apply a semi-liquid sealer around the outer edges.

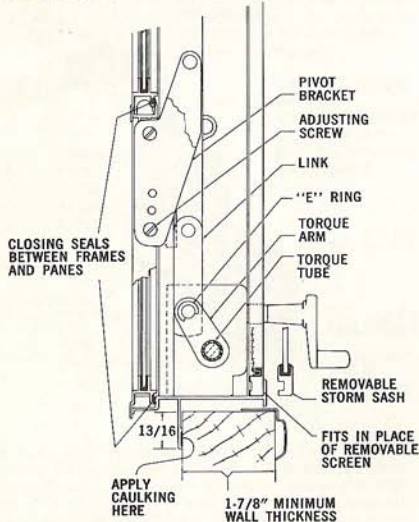

### SERVICE INSTRUCTIONS:

#### REMOVAL OF OPERATOR

If your window has an inner frame or wood inner frame that the shaft of the operator goes through, it will be necessary to remove the frame to clear the operator shaft before it can be removed. Also, if the vents are smaller than 18" wide, the window will have to be removed from the wall. (See alternate method)

Rotate operator arm enough to relieve tension on side linkage... remove the "E" rings at the arms attached to the torque tube and pry them loose... remove handle on operator. Prop open the vents enough to secure working room. Carefully center punch the 2 rivet heads on the operator and drill off the heads with a  $\frac{1}{4}$ " inch drill. Then punch the rivets out with a  $\frac{1}{8}$ " inch drift punch. Also, drill off the heads on the rivets of the tube bearing at the other end of the torque tube and punch out the rivets with the same punch. Note the position of torque arms before removing.

Close the vents. Insert a screwdriver behind the bearing and

pry from the side, lift the torque tube and bearing straight up the jamb until the bearing can be pushed off the end of the tube. This will allow the tube to be pulled from the operator. The operator can now be pried out.

#### RE-INSTALLATION OF OPERATOR

Place new operator into window jamb. Turn handle counter-clockwise as far as it will go. Insert tube with arm pointing up (be sure tube goes in same way as it came out), raise end of tube opposite operator as high as necessary to slip on bushing. Then lower in place and align holes. Be sure the projections on the back of the operator are in holes provided. Screw in 2 large flat head (#10 x  $1\frac{1}{2}$ " ) wood screws into the studs. Align the holes in the tube bearing on the opposite side and use #6 x  $\frac{3}{4}$ " round head wood screws (4) to attach firmly to the side. Align link stud with holes in arms on the bar, press in place and lock with the "C" washers. Secure the crank in place and return the screen.

#### ALTERNATE OPERATOR REPLACEMENT PROCEDURE REMOVAL OF THE OPERATOR

Remove all mounting screws and pull the window out of the opening. Open it and pull the "E" retainer ring off the stud holding the link to the torque arm. Drill out from outside two rivets holding the operator in place. Remove two bottom screws holding the sill to the side piece on operator side and loosen two top screws. Move the side slightly apart from sill and pull the operator out.

#### RE-INSTALLATION OF THE OPERATOR

Place the torque tube into the operator bearing and align mounting holes. Install the operator using two bolts (#10 flat head x  $\frac{3}{4}$ " long) and two nuts instead of rivets. Place the side piece back in position and re-install two bottom screws. Tighten two top screws. Re-install the link with the "E" retainer ring. Recaulk all joints. Re-install the window. See installation procedure for re-installing window.

#### VENT ADJUSTMENT

If a vent does not close down properly, adjusting holes have been provided. These holes are in the pivot brackets. There are two screws holding each end of the vent to the pivot bracket. The upper screw must always keep its position, while the lower one is for adjusting the vent closure. The lower screw should move up to the next hole to tighten the closure or down to relieve this closure, if it has been adjusted too tight.

**CAUTION:** Do not remove all four screws holding the vent unless you wish to remove it from the window frame for replacement of glass.

#### DISASSEMBLY OF VENT

Remove the screws from the four corners of the vent frame. Place a block of wood against the inner side of the frame and tap against the wood, working it evenly across the piece being removed, until it comes off the glass.

#### INSTALLATION OF NEW VENT GLASS

The vent glass is  $\frac{1}{2}$ " less than the vent side piece length, and  $1\frac{1}{4}$ " less than the vent bottom piece length. Replace the channel rubber on the new glass. If the channel rubber has been damaged to the extent that it is not usable, you can obtain a new seal through your local supplier or our plant. Install the top and bottom pieces first. Be sure they are centered on the glass, then tap them on evenly from end to end until they are firmly seated on the glass. Assemble the side pieces to the glass following this same procedure. Install the screws in the four corners. Before re-installing the vent in the window, check to see that the vent is squared. If not, it may be squared by tapping on the corner with the short angle until it is squared.

#### SCREEN FRAME AND STORM SASH REMOVAL

Removal of Broken Glass and Reglazing of the Stationary Portion of Combination Windows

Removing the Screen

Installing the Screen

Roll Formed Storm Sash Reglazing

See respective paragraphs on page 5

Hall-Mark Lite-Aire (Wide Louver) Windows 2400 Series

Hall-Mark Multi-Tork Windows 3500 & 3600 Series

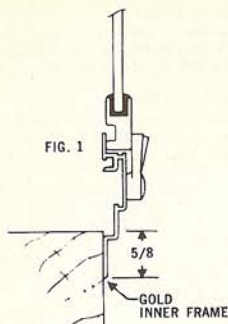

**INSTALLATION OF GOLD INNER FRAME**

At the bottom and one side of the window, mark the inner wall  $\frac{5}{8}$ " from the edge of the hole cut-out (Fig. 1). Place the edges of the inner frame against the marks and fasten the bottom side. Use #6 x  $\frac{3}{4}$ " sheet metal or wood screw for fastening. After fastening the bottom, square the frame using a carpenter's square, or insert the storm sash and use it as a guide. Install the screws in the rest of the frame.

On gold inner frame, storm sash clips are factory installed. Insert the storm sash in the frame and turn the clips to secure the storm sash.

**STORM SASH REGLAZING INSTRUCTIONS**

See Page 5

**HALL-MARK 17 OPENING AND COMBINATION WINDOWS**

**INSTALLATION INSTRUCTIONS:**

**HOLE CUT-OUT**

Check the window opening to see that it is square and plumb. If metal garnish is to be used, be sure sufficient clearance has been provided.

**CAULKING**

Apply the caulking to the back side of the mounting flange, keeping it as close to the outside edge of the window as possible.

**INSTALLATION OF THE WINDOW**

Fasten the window to the trailer wall, using #8 x  $1\frac{1}{4}$ " cad-plated steel sheet metal screws. Install the screws at the top of the window first. Check to see that the window is square and then install the remaining screws. Remove the excess caulking from around the outside of the window and apply a liquid sealer around the edge of the window.

**SERVICE INSTRUCTIONS:**

**REMOVAL OF THE FRONT FRAME**

Open the window as far as possible. Remove the two screws holding the operator to the trailer wall, and slide the arm end of the operator towards the hinged side of the window until it is almost out of the front channel. From the outside, lift the window open, push the operator arm out of the channel being sure you do not lose the friction device on the end of the arm. Remove the screw that is located in the center of the outside hinge. Open the front frame approximately 90 degrees, and slide it out of the back frame. Do not lose the plastic insert that is inside the hinge.

**REGLAZING THE FRONT FRAME**

Remove the two screws fastening the inside channel to the frame. Insert an ice pick or similar object into the glass seal at a corner of the window and pry it out until it can be grasped with the fingers and pulled out. To remove the glass, start at a corner, pressing against the glass until it releases from the sealing tape. Continue around the window until the glass is free. If the glass will not release from the tape, apply a small amount of heat to the extrusion directly in back of the sealing tape. If the adhesive sealing tape has been torn, remove all of it and either acquire a new tape (Part No. 009-140) or use a suitable metal sash glazing putty. When installing the new tape, make sure that at the corners the tape touches but does not overlap. If using metal sash glazing putty, it should be applied about  $\frac{1}{16}$ " thick. Cut the new glass  $\frac{1}{16}$ " smaller in length and width than the opening thru which it passes or, if possible, measure the old glass. Chip or clip off approximately  $\frac{3}{16}$ " across all four corners of the new glass. Insert the glass, leaving approximately  $\frac{1}{32}$ " border between the edge of the glass and the wall of the ex-

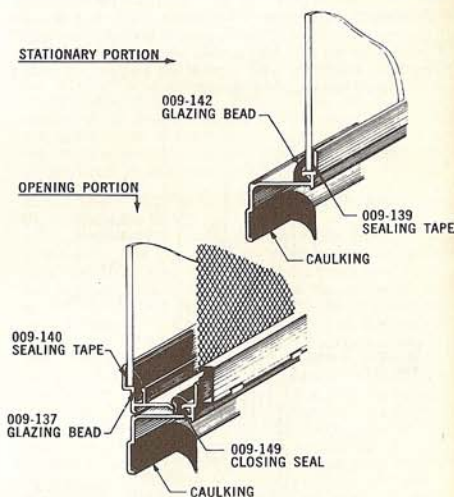

trusion. To install the glazing clip, start at one corner and push the edge of the clip under the edge of the extrusion until it is sealed. Do this for a few inches and then start at the opposite corner of the same strip. Finish this strip, working to the center from both ends. Repeat this procedure on the remaining three strips. Re-install the front channel. Re-install the front in the back frame in the reverse procedure as noted in "Removal of Front Frame." Be sure to install the plastic insert in the hinge when installing the front frame.

**REGLAZING THE STATIONARY PORTION**

Remove the glazing bead by inserting an ice pick into the corner and prying outwardly until it can be grasped with the fingers and pulled out. Before removing the glass, measure it so that you will know what size your new piece of glass should be. To remove the glass, start at a corner and press against the back of the glass until it releases from the sealing tape. Continue around the window until the glass is free. If the adhesive sealing tape has been torn, remove all of it and acquire a new tape (Part No. 009-140). When installing the new tape, make sure that at the corners the tape touches but does not overlap. If using sash glazing putty, it should be applied about  $\frac{1}{16}$ " thick. Install the new piece of glass, being sure that the edge of the glass does not touch the aluminum frame at any point. Re-install the glazing bead, starting at one corner and pressing it directly into the extru-

sion until you feel it "lock." Do this for a few inches, then start at the opposite corner of the same strip. Finish this strip, working to the center from both sides. Repeat this procedure on the remaining three sides.

#### RESCREENING

##### REMOVAL OF THE OPERATOR

Open the window as far as possible. Remove the two screws holding the operator to the channel and slide the arm end of the operator towards the hinged side of the window until it is almost out of the front channel. From the outside, lift the window open, push the operator arm out of the channel, being sure you do not lose the friction device on the end of the arm.

##### REMOVAL OF THE SCREEN FRAMES

Release the clips that hold the screen frame to the window by pressing them away from the frame.

##### REMOVING THE SCREEN

Remove the screen spline from the groove and pull the screen out.

#### INSTALLING THE SCREEN

It is advisable, before attempting to re-screen the frame, to make some provision to keep the frame square, its sides parallel and prevent the tension of the screen from bowing them inward. This can be done by nailing four (4) pieces of 1/4" thick wood to a flat surface in a manner which will permit you to slip the screen frame over the outside of them. These blocks of wood will then act as spreaders, keeping the frame square and from bowing in while the screen and spline are being rolled into the groove. Measure the widest part of the screen frame and add about 2" to the height and width for the new size. This is to allow for trimming after the screen has been installed. For the best results use fiberglass screen. Lay the new screen against the frame and leave about 1" overlapping the spline groove. Start at one corner and work the spline into the groove with a blunt screwdriver or similar tool. Always hold a tight tension on the screen in the direction you are working. Repeat this procedure working around the frame, finishing at the corner from which you started. Recheck the screen frame to determine that the frame is square and the sides are parallel, then trim the excess with a razor blade or sharp knife.

### STORM SASH, OUTSIDE MOUNTED—Hall-Mark 17 Single Pane, Tiered and Combination Windows

#### INSTALLATION INSTRUCTIONS:

##### OPENING SECTION

Open the window about 2". Insert the storm sash into the groove on the hinge side of the front frame (Fig. 2) pushing it as far into the groove as it will go. Center the storm sash on the front frame before lowering it into place. Snap the spring retainer clips (furnished) to the storm sash and front frame (Fig. 3), placing them as required.

##### CLIP PLACEMENT

Sides	
115	... 0 clips
151	... 1 clip
185	... 2 clips
185	... 2 clips
291	... 3 clips
325	... 4 clips
395	... 4 clips

##### Side opposite hinge

Clips to be mounted 2" in from each corner, the remaining evenly spaced.

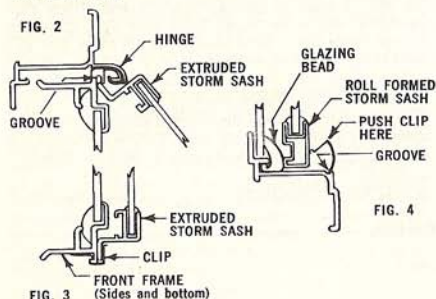

#### STORM SASH REGLAZING INSTRUCTIONS:

##### EXTRUDED STORM SASH

##### GLASS SIZE

Before disassembling the storm sash, measure the overall size of the frame. Subtract from these dimensions 1/8" inches, this will give you the cut size for the new glass.

##### DISASSEMBLY OF THE FRAME

To disassemble the frame, the drive screws at the corner of the frame must be removed. These can be removed by knocking them out from the back side. To remove the frame pieces from the glass, place a block of wood against the inner side of the frame and tap against it. Start at one end and tap back and forth against the part until it comes off the glass. Repeat this procedure on the other three pieces.

##### REASSEMBLY OF THE FRAME

Replace the "U" channel glazing bead on the new glass. Center a part (without the corners) on the glass and tap it down evenly until it "bottoms." Leave the corners for the two parts installed last. Next, install the side opposite the one you have installed. Insert the corners into the remaining two sides and install these to the glass. After all the pieces are on and the corners tight, replace the drive screws and caulk the corners with a suitable liquid sealer.

##### ROLL FORMED STORM SASH

##### GLASS SIZE

Before disassembling the storm sash, measure the overall size of the frame. Subtract from these dimensions one inch. This will give you the cut size for the new glass.

##### DISASSEMBLY OF THE FRAME

To remove the frame pieces from the glass, place a block of wood against the inner side of the frame and tap against it. Start at one end and work back and forth across the part until it comes off the glass. Repeat this procedure on the other three sides.

##### REASSEMBLY OF THE FRAME

Replace the "U" channel glazing bead on the new glass. Center a part (without the corners) on the glass and tap it down evenly until it "bottoms." Leave the corners for the two parts installed last. Next, install the side opposite the one you have installed. Insert the corners in the remaining two sides and install them. This completes the assembly of the storm sash.

#### REGLAZING

It is suggested that this storm sash can be factory reglazed, or that a new one be purchased as a replacement. For replacement storm sash please send the model number and size located on the outside mounting flange of the window.

#### STATIONARY SECTION

##### CLIP INSTALLATION AND PLACEMENT

Place the unformed edge of the spring clip into the groove that is located toward the outside edge of the extrusion (Fig. 4) and then push against the opposite end of the clip until it snaps in behind the storm sash. Clips (furnished) are to be placed 3" in from each corner on all four sides, then spaced equally but not more than 18" apart.

##### INSTALLATION OF STORM SASH

Insert storm sash into the recessed stationary, resting it against the stationary glazing bead. Lift the bottom of the storm sash 1/16" and install the clips as outlined above.

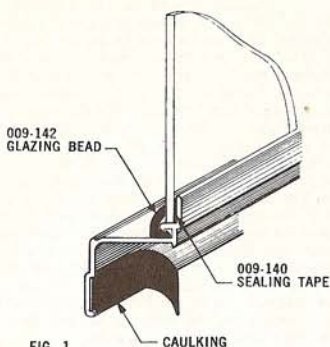

FIG. 1

**INSTALLATION INSTRUCTIONS:**

**HOLE CUT-OUT**

Check the window opening to see that it is square and plumb. If metal garnish is to be used, be sure sufficient clearance has been provided.

**CAULKING**

Apply the caulking to the back side of the mounting flange, keeping it as close to the outside edge of the window as possible.

**INSTALLATION OF WINDOW**

Fasten the window to the trailer wall, using #8 x 3/4" steel cadmium-plated sheet metal screws. Install the screws at the top of the window first. Check to see that the window is square and then install the remaining screws. Remove the excess caulking from around the outside edge of the window and apply a liquid sealer around the edge of the window at the trailer wall.

**SERVICE INSTRUCTIONS:**

**REGLAZING**

Remove the glazing bead by inserting an ice pick into the corner and prying outward until bead can be grasped with the fingers and pulled out. Before removing the glass, measure it so that you will know what size your new piece of glass should be. To remove the glass, start at a corner and press against the back of the glass until it releases from the sealing tape. Continue around the window until the glass is free. If the adhesive sealing tape has been torn, remove all of it and acquire a new tape. When installing new tape, make sure that at the corners the tape touches but does not overlap. If using sash glazing putty, it should be applied about 1/16" thick. Install the new piece of glass, being sure that the edge of the glass does not touch the aluminum frame at any point. Re-install the glazing bead, starting at one corner and pressing it directly into the extrusion until you feel it "lock." Do this for a few inches, then start at the opposite corner of the same strip. Finish this strip, working to the center from both sides. Repeat this procedure on the remaining three sides.

**STORM SASH, OUTSIDE MOUNTED—Model 1717, 1720, and 1790 Stationary Windows**

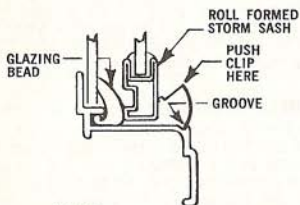

FIG. 2

**INSTALLATION INSTRUCTIONS:**

**CLIP INSTALLATION AND PLACEMENT**

Place the unformed edge of the spring clip into the groove that is located towards the outside edge of the extrusion (Fig. 2) and then push against the opposite end of the clip until it snaps in behind the storm sash. These clips (furnished) are to be placed 3" in from each corner on all four sides. Space them equally but not more than 18" apart on the remaining distance.

**INSTALLATION OF STORM SASH**

Insert the storm sash into the recessed stationary, resting it against the stationary glazing bead. Lift the bottom of the storm sash 1/16" and install the clips as outlined above.

**REGLAZING INSTRUCTIONS:**

See Page 8

**INNER FRAME AND STORM SASH—Model 1717 Stationary Windows**

(Can be used only where wall thickness is a minimum of 1 7/8 inches)

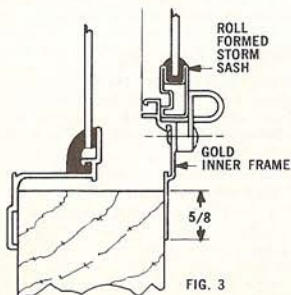

FIG. 3

**INSTALLATION INSTRUCTIONS:**

**INSTALLATION OF GOLD INNER FRAME**

At the bottom and one side of the window, mark the inner wall 5/8" from the edge of the hole cut-out (Fig. 3). Place the edges of the inner frame against the marks and fasten the bottom side. Use #6 x 3/4" sheet metal or wood screw for fastening. After fastening the bottom, square the frame using a carpenter's square, or insert the storm sash and use it as a guide. Install the screws in the rest of the frame.

On gold inner frame, storm sash clips are factory installed. Insert the storm sash in the frame and turn the clips to secure the storm sash.

## HALL-MARK SLIDING WINDOWS 2500 SERIES

### INSTALLATION INSTRUCTIONS:

#### HOLE CUT-OUT

The opening in which the window is to be installed must be of adequate size to give proper clearance. The top, bottom and sides of the opening must be square to each other and level.

#### CAULKING

Apply a suitable non-hardening type caulking to the back side of the mounting flange, keeping it close to the outside edge of the window. Apply enough to be sure it will fill in any irregularities in the outside surface around the hole in which the window is being installed.

#### INSTALLATION

When installing the window be sure vents are in closed position, this helps keep the window squared during installation. The window should be centered in the hole, leaving approximately  $\frac{1}{8}$ " clearance all around the inside portion (use shims if necessary), this clearance will permit the use of a metal garnish. Suggested installation screws are #8 x  $1\frac{1}{4}$ " Type "A," binder head, aluminum or steel cadmium plated sheet metal screws. Install these screws straight into the wall, starting at the top of the window, after the first few screws are installed, check to be sure the window is still centered and square in the hole then install and tighten the remaining screws. Remove the excess caulking from around the outer edge of the window and apply a semi-liquid sealer all around the outer edge.

#### SERVICE INSTRUCTIONS:

##### REMOVAL OF SLIDING VENT

The sliding vent can be removed from the frame by sliding it to the full open position, raising it up into the top frame and pulling out at the bottom.

##### DISASSEMBLY OF SLIDING VENT

Before disassembly, measure the outside of the frame, height and width. The new glass (DSB) should be cut  $1"$  less than the overall dimensions. Remove the screws from the four corners of the frame. Place a block of wood against the inner side of the frame and tap against the wood. It is best to start at one end of the frame piece and work evenly to the other end until the frame comes off the glass. Repeat this procedure on the other three sides.

##### INSTALLING NEW GLASS

Replace the channel rubber on the new glass. If the channel rubber has been damaged to the extent that it is not reusable, you can obtain a new seal through your local supplier or our factory. Install the top and bottom frame pieces first. Be sure they are centered on the glass and then tap them evenly from end to end until they are firmly seated on the glass. Make sure the weatherstripped side is facing the same way on the parts. Install the other two frame pieces as mentioned previously. Install the screws in the four corners. Before reinstalling the vent in the window, use a carpenter's square; check to see that the vent is square. If not, tap on the opposite corner until square.

##### REMOVAL OF THE SCREEN FRAMES

Release the clips that hold the screen frame to the window by pressing them away from the frame.

##### REMOVING THE SCREEN

Remove the screen spline from the groove and pull the screen out.

#### INNER FRAME AND STORM SASH—Hall-Mark Sliding Windows 2500 Series

##### INSTALLATION OF GOLD INNER FRAME

At the bottom and one side of the window, mark the inner wall  $\frac{5}{8}"$  from the edge of the hole cut-out (Fig. 1). Place the edges of the inner frame against the marks and fasten the bottom side. Use #6 x  $\frac{3}{4}"$  sheet metal or wood screw for fastening. After fastening the bottom, square the frame using a carpenter's square, or insert the storm sash and use it as a guide. Install the screws in the rest of the frame.

On gold inner frame, storm sash clips are factory installed. Insert the storm sash in the frame and turn the clips to secure the storm sash.

##### STORM SASH REGLAZING INSTRUCTIONS (ROLL FORMED)

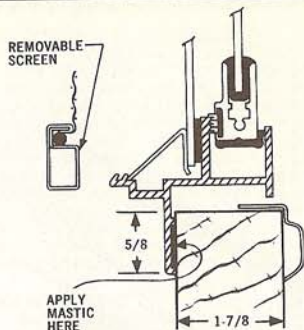

#### INSTALLING THE SCREEN

It is advisable, before attempting to re-screen the frame, to make some provision to keep the frame square, its sides parallel and prevent the tension of the screen from bowing them inward. This can be done by nailing four (4) pieces of  $\frac{1}{4}"$  thick wood to a flat surface in a manner which will permit you to slip the screen frame over the outside of them. These blocks of wood will then act as spreaders, keeping the frame square and from bowing in while the screen and spline are being rolled into the groove. Measure the widest part of the screen frame and add about  $2"$  to the height and width for the new size. This is to allow for trimming after the screen has been installed. For the best results use fiberglass screen. Lay the new screen against the frame and leave about  $1"$  overlapping the spline groove. Start at one corner and work the spline into the groove with a blunt screwdriver or similar tool. Always hold a tight tension on the screen in the direction you are working. Repeat this procedure working around the frame, finishing at the corner from which you started. Recheck the screen frame to determine that the frame is square and the sides are parallel, then trim the excess with a razor blade or sharp knife.

#### REGLAZING STATIONARY SECTION

##### REMOVING BROKEN GLASS

Remove the mitered glass clips first, then the straight. To remove the clips, insert a hook type paint scraper or similar tool under the edge of the clip next to glass, starting at one end and with a slight rocking action work the clip out. Remove broken pieces of glass and clean rubber seal; be sure there are no small pieces of glass imbedded in the rubber seal.

##### INSTALLING NEW GLASS

If the rubber has been broken or damaged in removing the old glass, obtain a new seal from your supply store or in case of emergency use electrician's tape laminated to approximately  $\frac{1}{16}"$  thick. Cut your glass (DSB), leaving approximately  $\frac{1}{8}"$  between glass and frame when in place. Apply a rubber cement or other adhesive to the rubber seal before placing the glass in the frame. Center the glass and install clips, both straight clips first then the mitered clips, by placing the top edge of the clip in place and starting at one end, work the bottom in until the lip on the clip is hooked over the edge of the glass. Trim rubber seal with a razor blade if it protrudes beyond the frame after you have completed the above operations.

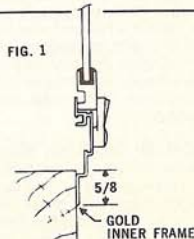

See Page 8

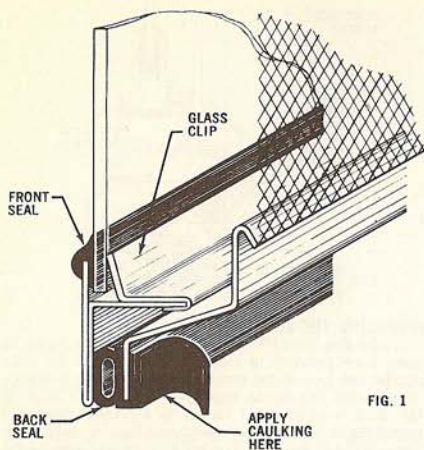

FIG. 1

**INSTALLATION INSTRUCTIONS:****HOLE CUT-OUT**

To insure proper operation and sealing of the window, check the hole cut-out to see that it is square and that proper clearance has been provided. If the trailer wall is corrugated or ribbed, flatten the immediate area around the edge of the hole at least the width of the window mounting flange.

**CAULKING**

We recommend a non-hardening type of caulking. Apply the caulking all around the mounting flange, Fig. 1, keeping it as close to the outside edge of the frame as possible.

**INSTALLATION**

After the flange has been caulked, open the pane or panes as far as possible and set the window into the hole. Use #6 x 3/4" cad-plated steel sheet metal screws for fastening. On the side of the window that is opposite the hinge, fold back the rubber bulb seal and fasten the side securely to the trailer through the pre-punched holes in the aluminum frame. Next, fasten the hinge side of the window. On the remaining two sides fasten under the bulb seal. Remove the excess caulking from around the edge of the window. Apply a liquid sealer completely around the edge of the window.

**INSTALLATION OF DRIP CAP**

Apply caulking to the back edge of the drip cap in line with the pre-punched mounting holes. Place the drip cap at the preferred height above the window and fasten securely. Clean off any excess caulking and, using the liquid sealer, run a bead around the edge of the drip cap as was done on the window.

**SERVICE INSTRUCTIONS:****REMOVAL OF THE FRONT FRAME, LEVER OPERATED**

Open the window and remove the screw that fastens the operating lever to the front channel. The lever can now be removed from the window. At either end of the back frame hinge there is a tab bent over the hinge opening. Straighten one of these out to allow the front frame to be removed. On french windows the front frame can be removed only from the top. Swing the front frame open far enough so that the hinged side of the front will clear the back frame and slide the front out.

**REMOVAL OF THE FRONT FRAME, GEAR OPERATED**

Crank the operator so the window is full open and then remove the two screws holding the operator to the back channel. From the outside of the window, push the end of the operator that is attached to the front channel upward until the operator can be removed thru the slot in the channel.

Be careful when removing that you don't lose the friction device attached to the end of the operator. At either end of the back frame hinge there is a tab bent over the hinge opening. Straighten one of these out to allow the front frame to be removed. On french windows the front frame can be removed only from the top. Swing the front frame open far enough so that the hinged side of the front will clear the back frame and slide the front out.

**GLASS REMOVAL AND REPLACEMENT**

To remove the glass place the front on a flat surface with the inside up. Remove the screws from the channel. Before removing it from the frame, note in what relationship the hole or holes lie with the hinge side of the window. In gear operated windows the slotted end of the channel is toward the hinge. Remove the remaining screws from around the window. Remove the glass clips and take out the broken glass, using care not to injure the rubber seal. Cut the new glass, double strength, 1/8" less length and width than the inside measurement of the flanges. Re-install the glass in the reverse procedure as outlined before, with the exception that you leave the screws loose until they are all in place before tightening. Re-install the front in the back frame.

**LEVER REPLACEMENT**

Open the window and remove the screw that fastens the operating lever to the front channel. The lever can now be removed from the window.

**OPERATOR REPLACEMENT**

Crank the operator so the window is full open and then remove the two screws holding the operator to the back channel. From the outside of the window, push the end of the operator that is attached to the front channel upward until the operator can be removed thru the slot in the channel. Be careful when removing that you don't lose the friction device attached to the end of the operator.

**BACK CHANNEL REPLACEMENT**

Remove the operating mechanism, lever or operator, from the window as noted in previous instructions. Remove (if any) the grommet holding the screen to the channel by straightening the tabs with a screwdriver from the inside of the channel and pushing it out. If there is a hook to which the lever is locked, remove this by drilling out the rivets with a 5/16" dia. drill. To remove the channel from the back frame use a 1/8" dia. drill to drill out the rivets. When refastening the channel we suggest you use #4-40 x 1/4" screw with nuts or 1/8" dia. cherry rivets. To replace the hook use #8-32 x 3/16" screws with nuts or 5/32" dia. cherry rivets.

**FRONT SEAL REPLACEMENT**

Remove the front and glass from the window as described previously. Remove the old seal and replace with the new one, using a suitable cement for bonding the vinyl seal to the aluminum frame. Assemble the window and re-install in the frame.

**BACK FRAME SEAL REPLACEMENT**

Open the front pane or panes as far as they will open. Remove the mounting screws or nails under the back edge seal on the two sides and bottom and pull the window loose from the trailer wall. Remove the old seal from the frame. Note the manner in which the seal has been mitered. When installing the new seal start at the hinged side of the window working around the frame to the opposite side. After the seal has been cut and fitted, remove the seal and to the trailer side of the window apply a generous quantity of a suitable rubber to aluminum cement. Re-install the rubber and push the window back into the hole and allow the cement to set. Re-install the window in the trailer as previously noted in the caulking and installation procedures.

**RESCREENING**

It is possible to re-screen the window, but it is our suggestion that as the window has to be removed from the trailer you take it to a service depot or send it to one of our plants for repair. In some cases, it may be wise to purchase a new back frame to take advantage of the new seats, frame, etc.

## STANDARD COMBINATION WINDOWS

### INSTALLATION INSTRUCTIONS:

#### HOLE CUT-OUT

To insure proper operation and sealing of the window, check the hole cut-out to see that it is square and that proper clearance has been provided. If the trailer wall is corrugated or ribbed, flatten the immediate area around the edge of the hole at least the width of the window mounting flange.

#### CAULKING

We recommend a non-hardening type of caulking. Apply the caulking all around the mounting flange, Fig. 1, keeping it as close to the outside edge of the frame as possible.

#### INSTALLATION

Before installing the window in the hole, place  $\frac{1}{8}$ " thick shims along one side and the bottom so the window will be centered in the hole. Use #6 x  $\frac{3}{4}$ " cad-plated steel sheet metal screws for fastening the window to the trailer thru the pre-punched holes in the flange. After the window has been installed, remove the excess caulking from around the edge of the window. Apply a liquid sealer completely around the edge of the window.

#### INSTALLATION OF DRIP CAP

Apply caulking to the back edge of the drip cap in line with the pre-punched mounting holes. Place the drip cap at the preferred height above the window and fasten securely. Clean off any excess caulking and, using the liquid sealer, run a bead around the edge of the drip cap as was done on the window.

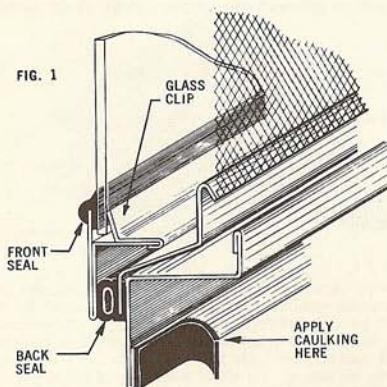

### SERVICE INSTRUCTIONS:

#### REMOVAL OF THE FRONT FRAME, LEVER OPERATED

Open the window and remove the screw that fastens the operating lever to the front channel. The lever can now be removed from the window. At either end of the back frame hinge there is a tab bent over the hinge opening. Straighten one of these out to allow the front frame to be removed. On french windows the front frame can be removed only from the top. Swing the front frame open far enough so that the hinged side of the front will clear the back frame and slide the front out.

#### REMOVAL OF THE FRONT FRAME, GEAR OPERATED

Crank the operator so the window is full open and then remove the two screws holding the operator to the back channel. From the outside of the window, push the end of the operator that is attached to the front channel upward until the operator can be removed thru the slot in the channel. Be careful when removing that you don't lose the friction device attached to the end of the operator. At either end of the back frame hinge there is a tab bent over the hinge opening. Straighten one of these out to allow the front frame to be removed. On french windows the front frame can be removed only from the top. Swing the front frame open far enough so that the hinged side of the front will clear the back frame and slide the front out.

### GLASS REMOVAL AND REPLACEMENT

To remove the glass, place the front on a flat surface with the inside up. Remove the screws from the channel. Before removing it from the frame, note in what relationship the hole or holes lie with the hinge side of the window. In gear operated windows the slotted end of the channel is toward the hinge. Remove the remaining screws from around the window. Remove the glass clips and take out the broken glass, using care not to injure the rubber seal. Cut the new glass, double strength,  $\frac{1}{8}$ " less length and width than the inside measurement of the flanges. Re-install the glass in the reverse procedure as outlined before, with the exception that you leave the screws loose until they are all in place before tightening. Re-install the front in the back frame.

### LEVER REPLACEMENT

Open the window and remove the screw that fastens the operating lever to the front channel. The lever can now be removed from the window.

### OPERATOR REPLACEMENT

Crank the operator so the window is full open and then remove the two screws holding the operator to the back channel. From the outside of the window, push the end of the operator that is attached to the front channel upward until the operator can be removed thru the slot in the channel. Be careful when removing that you don't lose the friction device attached to the end of the operator.

### BACK CHANNEL REPLACEMENT

Remove the operating mechanism, lever or operator, from the window as noted in previous instructions. Remove (if any) the grommet holding the screen to the channel by straightening the tabs with a screwdriver from the inside of the channel and pushing it out. If there is a hook to which the lever is locked, remove this by drilling out the rivets with a  $\frac{5}{32}$ " dia. drill. To remove the channel from the back frame, use a  $\frac{1}{8}$ " dia. drill to drill out the rivets. When refastening the channel, we suggest you use #4-40 x  $\frac{1}{4}$ " screw with nuts or  $\frac{1}{8}$ " dia. cherry rivets. To replace the hook use #8-32 x  $\frac{3}{16}$ " screws with nuts or  $\frac{5}{32}$ " dia. cherry rivets.

### FRONT SEAL REPLACEMENT

Remove the front and glass from the window as described previously. Remove the old seal and replace with the new one using a suitable cement for bonding the vinyl seal to the aluminum frame. Assemble the window and re-install in the frame.

### BACK SEAL REPLACEMENT

Open the front pane or panes as far as they will open. Remove the mounting screws under the back edge seal and along the sides of the back frame. It is not necessary to remove the rivets or screws holding the hinged side as the frame can be pulled out enough to remove and replace the seal. Note the manner in which the seal has been mitered at the corners before removing it from the window. When installing the new seal, start at the hinged side of the window working around the frame to the opposite side. After the seal has been cut and fitted, remove the seal and to the trailer side of the window apply a generous quantity of a suitable rubber-to-aluminum cement. Re-install the rubber and push the window back into the hole and allow the cement to set. Replace the screws in the frame and tighten securely. Apply a suitable liquid cement on the edge of the rubber where it meets the frame as it was originally.

### RESCREENING OR REMOVAL OF BACK FRAME

It is possible to rescreen the window, but it is our suggestion that as the window has to be removed from the trailer, you take it to a service depot or send it to one of our plants for repair. In some cases, it may be wise to purchase a new back frame to take advantage of the new seals, frame, etc. To remove the opening section back frame from the combination frame, the rivets at the top of the frame must be drilled out. Then the screws around the inner part of the frame must be removed. When re-installing the windows, use #6 x 4" aluminum or cad-plated steel screws in place of the rivets.

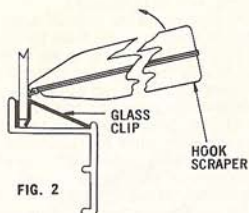

FIG. 2

#### REGLAZING OF STATIONARY WINDOWS — REMOVAL OF THE BROKEN GLASS

Obtain a hook scraper for removal of glass chips. A suitable hook scraper for this is a #15 hook scraper manufactured by Hookscraper Co., Inc., Queens Village, New York. This may be purchased in most hardware stores. Remove the

glass clips that have the mitered ends first. These are usually the vertical clips. When removing the clips, be sure and start at one end and work to the opposite end, the clip will then pop out. Force the edge of the scraper under the glass clip and apply a slight pressure towards the glass (Fig. 2). Remove the broken glass, being careful not to damage the rubber seal. Remove all the small chips of glass and foreign particles from the surface of the rubber seal.

#### INSTALLING NEW GLASS

Cut new glass D.S.B.  $\frac{1}{8}$ " height and width less than the narrowest part of the opening. If the rubber seal has been damaged, obtain a new seal from your local trailer supply store or laminate rubber electrician's tape to a thickness of  $\frac{1}{16}$ ". Use a suitable cement to bond the tape to the frame. Before installing the glass, apply a thin bead of cement around the seal. Install the new glass, centering it in the frame leaving approximately  $\frac{1}{8}$ " clearance all around. Install the straight clips and then the mitered clips. Trim off any excess of seal from the inside of the window and wipe free of cement.

#### CARE OF PLEXIGLAS-GLAZED WINDOWS

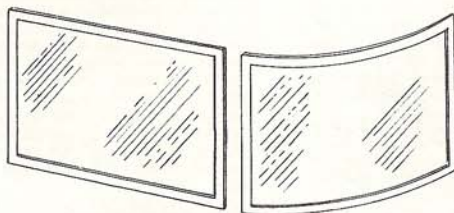

#### CLEANING INSTRUCTIONS:

Although PLEXIGLAS will withstand severe shock without breaking, its gem-like surface lustre may be marred by careless handling. Just as you take pride in caring for fine furniture or silverware, you will find it pays to take the simple precautions necessary to preserve the beauty of PLEXIGLAS.

- DO ... dust and clean PLEXIGLAS with a soft, damp cloth or chamois, wiping the surfaces gently.
- DO ... use pure soap and lukewarm water, if cleaning agents are necessary.
- DO ... dry the surfaces, after washing and rinsing, by blotting with a damp cloth or chamois.
- DO ... wax the surfaces sparingly for protection and to obtain the highest degree of polish. Apply a good commercial wax in a thin, even film with a soft clean cloth.
- DO ... polish the waxed surfaces lightly with clean cotton flannel or jersey. After polishing, wipe gently with a damp cloth to ground any electrostatic charges which may attract dust particles.

- DO NOT ... use boiling water, strong solvents such as alcohol, acetone, carbon tetrachloride, etc., or window cleaning fluids which may contain such solvents, to clean PLEXIGLAS as they will soften the plastic.
- DO NOT ... subject PLEXIGLAS to hard direct blows. Handle it with the care its beauty deserves. PLEXIGLAS is highly shatter-resistant and will stand up under most impacts, but it is not unbreakable.
- DO NOT ... use cloths containing grit or abrasive particles or kitchen scouring compounds to clean or dust PLEXIGLAS. Like beautiful wood or fine silver, PLEXIGLAS can be scratched. But, unlike most other materials, a scratch on the surface of PLEXIGLAS can be removed. A minor scratch may be rubbed out with a household wax; a deep scratch can be buffed out.



**INSTALLATION INSTRUCTIONS:**

**HOLE CUT-OUT**

The hole cut-out for 900, and 9171 should be 14"x14" square, and hole cut-out for 9153 should be 17"x17" square. This is 1/4" larger than the ventilator to allow for installation of metal garnish if required.

**CAULKING AND INSTALLATION OF VENTILATOR FRAME**

It is necessary to remove the ventilator lid before the ventilator frame can be installed. To remove the lid, fully open the ventilator, pull off the knobs and remove the screen.

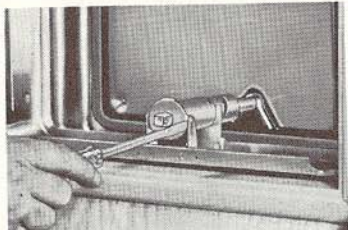

FIG. 1

Next, using a screwdriver, insert it between the actuator and actuator bracket (Fig. 1). Turn the screwdriver slightly facing the bracket to open up and push the actuator towards the center of the ventilator until it disconnects from the bracket. Repeat this procedure on the opposite actuator and remove the lid. Apply a suitable non-hardening caulking to



FIG. 2

the mounting flange (Fig. 2) keeping it as close to the edge of the flange as possible. Insert the ventilator frame into the hole cut-out with actuator brackets facing to the front and rear of the trailer. Fasten the frame to the trailer roof using #6 x 3/4" steel cad-plated sheet metal screws. After the frame has been fastened to the roof, remove the excess caulking from around the mounting flange and apply a suitable liquid sealer to the edge of the flange where it meets the roof.

**INSTALLATION OF THE LID**

Before installing the lid, check the actuator brackets to see if the support arms were bent out when removing the actuators. If so, squeeze them until they are parallel or slightly together. Place the lid over the ventilator frame with the actuators fully open and parallel to the actuator brackets. From the inside of the trailer, place an actuator into a bracket with the rivet hole in the actuator positioned with the pin in the actuator bracket. Twist the actuator toward the other pin until it snaps in place. Repeat this procedure with the other actuator and then test them to see that they are properly placed and work smoothly. Install the ventilator screen and knobs to complete the installation.

**SERVICE:**

**CARE OF THE ACTUATORS**

Approximately every six months clean and lubricate the actuators. Use a suitable non-volatile liquid cleaner and lubricate with a small amount of powdered graphite.

**REPLACEMENT OF LID, ACTUATORS, GASKET OR SKYLITE**

Due to the riveted construction of the ventilator lid it is necessary that it be replaced or repaired as a unit at the factory, if the lid, actuators, gasket or skylite have been damaged.

FIG. 3

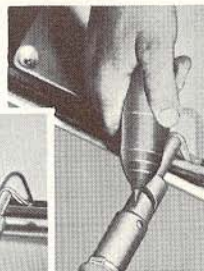
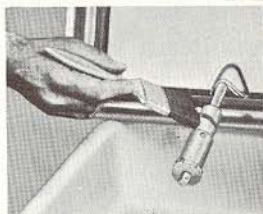

FIG. 4

**REMOVAL OF THE LID**

To remove the lid, fully open the ventilator, pull off the knobs and remove the screen. Next, using a screwdriver, insert it between the actuator bracket (Fig. 1). Turn the screwdriver slightly, forcing the bracket to open up and push the actuator towards the center of the ventilator until it disconnects from the bracket. Repeat this procedure on the opposite actuator. After the actuators have been disconnected lift the lid up until the actuators are outside. Stand the lid on edge and turn it across the diagonal corners. This way it can be lowered into the trailer from the inside.

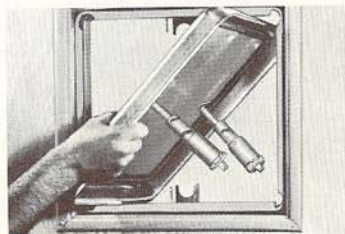
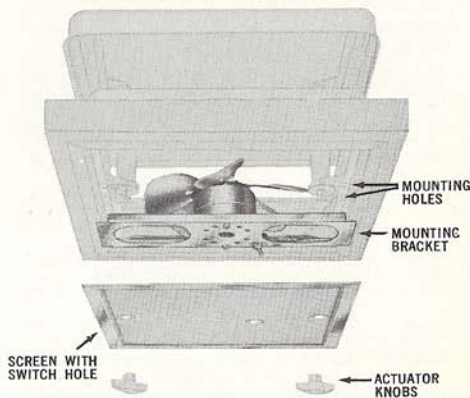

FIG. 5

**MODEL 940, POWER VENT KIT, 115 VOLT A. C.**  
**• MODEL 9130, POWER VENT KIT, 12 VOLT D. C.**



**INSTALLATION:**

Remove the actuator knobs and screen from the No-Draft Ventilator. Located on both sides of the ventilator frame, next to the actuators, should be two pierced holes for

mounting the power vent kit assembly. Take care not to damage the fan blade and place the power vent kit assembly over the two actuators and fasten it to the pre-pierced holes with the screws provided. Connect the two wires from the motor to the electric supply. Place the new screen with the switch hole on the ventilator and install the knobs.

**MODEL 931, POWER VENT ASSEMBLY, 115 VOLT A. C. (U. L. Listed, Not Switched)**

**MODEL 926, POWER VENT ASSEMBLY, 115 VOLT A. C. (Not U. L. Listed, Switched)**

**MODEL 9110, POWER VENT ASSEMBLY, 12 VOLT D. C.**

**INSTALLATION INSTRUCTIONS:**

**HOLE CUT-OUT**

The hole cut-out should be 14" x 14" square. This is 1/4" larger than the ventilator to allow for installation of metal garnish.

**PRE-WIRING AND CONNECTIONS**

It is necessary to run an electric supply to the hole cut-out for connection to the ventilator junction box. (On Model 931 the electric supply must come from a wall switch.) Looking up at the hole cut-out and facing the front of the trailer, drill a hole (diameter as required) 1" from the right hand corner and 3/16" down from the roof through the front hole cut-out stud. (Fig. 1.) Run the electric service through the hole and leave about 8" extending into the hole cut-out. Remove from the ventilator the junction box cover and install a connector as required in the hole provided.

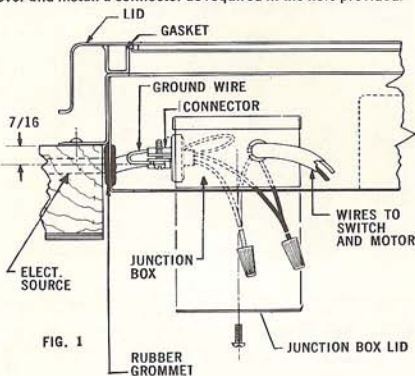

FIG. 1

**CAULKING AND INSTALLATION OF VENTILATOR FRAME**

It is necessary to remove the ventilator lid before the ventilator frame can be installed. To remove the lid, fully open the ventilator, pull off the knobs and remove the screen. Next, insert a screwdriver between the actuator and actuator bracket (Fig. 2). Turn the screwdriver slightly forcing the bracket to open up and push the actuator towards the center of the ventilator until it disconnects from the bracket.

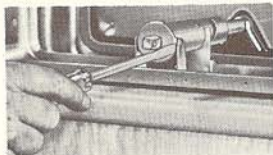

FIG. 2

Repeat this procedure on the opposite actuator and remove the lid, being careful not to damage the fan blade. Apply a suitable non-hardening caulking to the mounting flange (Fig. 3), keeping it as close to edge of the flange as possible. Insert the ventilator into the hole cut-out, with the junction box to the front and right side of the trailer, while threading the electric supply into the junction box. Fasten the frame to the trailer roof using #6 x 3/4" steel cad-plated sheet metal screws. After the frame has been fas-

**MOTOR CARE**

On Model 940 oil the motor every three months with a drop of S.A.E. 20 oil. Oil spouts are provided on the top and bottom of the motor for this purpose. On Model 9130 the motor is self oiled. For longer life of the motor, keep it wiped free of dirt and oil. Replacement parts are available on request.

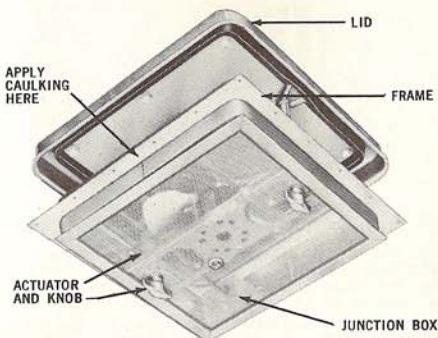

FIG. 3

tened to the roof, remove the excess caulking from around the mounting flange and apply a suitable liquid sealer to the edge of the flange where it meets the roof. Strip and connect the wires in the junction box, then test the unit to see that it works properly.

**INSTALLATION OF LID**

Before installing the lid, check the actuator brackets to see if the support arms were bent out when removing the actuators. If so, squeeze them until they are parallel or slightly together. Place the lid over the ventilator frame with the actuators fully open and parallel to the actuator brackets. From the inside of the trailer, place an actuator into a bracket with the rivet hole in the actuator positioned with the pin in the actuator bracket. Twist the actuator towards the other pin until it snaps in place. Repeat this procedure with the other actuator and then test them to see that they are properly placed and working smoothly. Install the ventilator screen and knobs to complete the installation.

**SERVICE INSTRUCTIONS:**

**CARE OF THE ACTUATORS**

Approximately every six months clean and lubricate the actuators. Use a suitable non-volatile liquid cleaner and lubricate with a small amount of powdered graphite.

**REPLACEMENT OF THE LID, ACTUATORS OR GASKET**

Due to the riveted construction of the ventilator lid it is necessary that it be replaced or repaired as a unit at the factory if lid, actuators or gasket have been damaged.

**REMOVAL OF THE LID**

To remove the lid, fully open the ventilator, pull off the knobs and remove the screen. Next, insert a screwdriver between the actuator and actuator bracket (Fig. 2). Turn the screwdriver slightly, forcing the bracket to open up and push the actuator towards the center of the ventilator until it disconnects from the bracket. Repeat this procedure on the opposite actuator. When the actuators have been disconnected lift the lid up, being careful not to damage the fan blades, and remove it from the ventilator.

**MOTOR CARE**

Oil the motor every three months with a drop of S.A.E. 20 oil. Oil spouts are provided on the top and bottom of the motor for this purpose, except 12 volt. For longer life of the motor keep it and the screen free of dirt and oil. Replacement parts available on request.

## STANDARD ROOF VENTILATORS

MODEL 979 and 9192 (FIXED SCREEN) • MODEL 9124 and 9196 (REMOVABLE SCREEN)

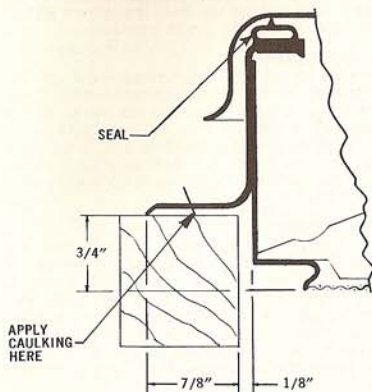

### INSTALLATION INSTRUCTIONS:

#### HOLE CUT-OUT

The hole cut-out required for the standard ventilator is a standard 14" x 14" square. This is 1/4" larger than the inside dimensions of the ventilator to allow for installation of metal garnish if required.

#### CAULKING

Apply a suitable non-hardening type of caulking to the mounting flange, keeping it as close to the outside edge as possible.

#### INSTALLATION

Install the ventilator with the hinged side facing the front of the trailer. Use #6 x 3/4" sheet metal screws for fastening. After the ventilator has been fastened securely to the trailer roof, remove the excess caulking from around the flange and apply a suitable liquid sealer to the edge of the flange where it meets the trailer roof.

#### SERVICE:

##### OPERATOR REPLACEMENT

Partially open the ventilator and then remove the two screws holding the operator. Pull the operator downward until it releases from the channel in the lid. On the end of the operator is a nylon friction device, this will have to be removed before the operator can be removed entirely. To install the new operator turn it until it is completely open, then insert it through the channel. If the operator is being replaced with the ventilator installed in the trailer, someone will have to attach the friction device to the end of the operator and start it in the channel from the roof. Install the operator mounting screws to complete the installation.

### MODEL 9108, JR. VENT

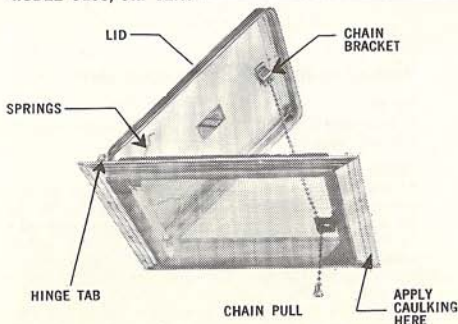

#### LID REPLACEMENT

Open the ventilator fully. Using 1/8" diameter drill, drill out the four rivets holding the lid hinge to the ventilator frame. Pull the lid off of the operator arm, being careful not to loosen the friction device on the end of the operator. Insert the friction device, attached to the operator arm, into the channel of the new lid and slide the lid down until properly positioned with the rivet holes in the frame. The hinge can be fastened with 1/8" diameter "Pop Rivets" or #4-40 x 1/4" screws and nuts.

#### SCREEN REPLACEMENT (Model 979)

To replace the screen it is necessary to remove the ventilator from the trailer. Remove the operator (see previous instructions) and then remove the screen. Acquire a new piece of aluminum mesh screen 14" x 14" square. Center the screen over the ventilator and using a blunt instrument or screen roller, roll the screen under the screen flanges. Start on one side and then the opposite so the screen will be tight. Replace the operator and re-install the ventilator. See caulking and installation instructions.

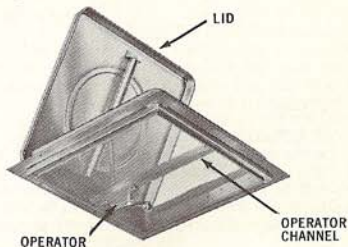

#### OPERATOR CHANNEL REPLACEMENT

Fully open the ventilator. Remove the two screws holding the operator to the channel. Slide the operator down the lid channel, being careful not to lose the friction device on the end of the operator when it comes out of the channel; remove the operator from the ventilator. Drill out the rivets holding the channel with a 1/8" diameter drill. The new channel can be fastened with 1/8" diameter "Pop Rivets" or #4-40 x 1/4" screws and nuts. Re-install the operator, being sure the friction device is properly attached to the operator arm.

#### SEAL REPLACEMENT (Model 979)<sup>o</sup>

Acquire a new length of seal (60") 009-130 from your local trailer supply house or our factory. Open the ventilator lid as far as possible. Remove the old seal, scraping off any that may remain. Apply a suitable vinyl to aluminum cement to the top of the seal mounting flange. Starting at the center of the hinged side, straddle the seal over the flange and continue around the flange to the point at which you started. Allow the cement to dry before closing the lid.  
<sup>o</sup>On Model 9192 factory replacement required.

### INSTALLATION INSTRUCTIONS:

#### HOLE CUT-OUT

A 9 1/2" square hole is required for installation of the ventilator. This is 1/4" larger than the inside dimensions of the ventilator to allow for installation of metal garnish.

#### CAULKING

Apply a suitable non-hardening type of caulking to the mounting flange. Keep it as close to the outside edges as possible.

#### INSTALLATION

Install the ventilator with the hinged side facing the front of the trailer. Use #6 x 3/4" sheet-metal screws for fastening. After the ventilator has been fastened securely to the roof, remove the excess caulking from around the flange and apply a suitable liquid sealer to the edge of the flange where it meets the roof.

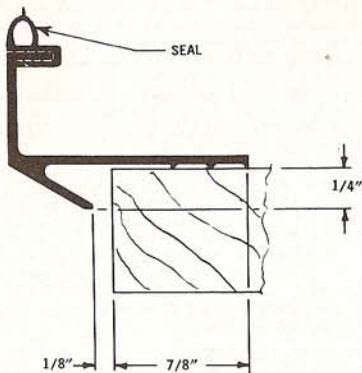

#### SERVICE:

##### **LID REPLACEMENT**

Remove the bell pull from the end of the pull chain and let the lid open fully. On each end of the hinge, that is fastened to the frame, there are tabs closing off the ends. Open one of these tabs and the lid can be "slid" out of the hinge. Install the new lid in the reverse procedure.

##### **CHAIN REPLACEMENT**

Remove the bell-pull from the end of the chain and let the lid open fully. On the lid side, pull the spring out from under the bracket and pull the chain through the bracket. Install the new chain in the reverse procedure.

##### **SPRING REPLACEMENT**

Fully open the lid and using a  $\frac{1}{8}$ " diameter drill, drill out one of the rivets holding the spring bracket to the frame. Bend the bracket out from the frame just enough so that the spring can be removed. Place the new spring on the bracket. Fasten the bracket to the frame using a  $\frac{1}{8}$ " diameter "Pop Rivet" or a #8 x  $\frac{1}{4}$ " sheet metal screw. Facing the rear of the ventilator and looking at the springs, order right or left hand as required.

##### **SEAL REPLACEMENT**

Acquire a new length of seal (60") #009-130 from your supply store or direct from our factory. Remove the old seal, scraping off any that may remain. Apply a vinyl to aluminum cement to the top edge of the seal flange. Start at the center, back, and install the seal to the first corner. At the corner and about  $\frac{3}{16}$ " back cut the seal partially through (see old seal) and continue around the corner with the seal. Repeat this procedure until all the seal has been installed.

##### **SCREEN REPLACEMENT**

Order a new screen from your trailer supply house or from our factory. The new screen will be supplied with two sides folded and the grommet attached. Remove the ventilator folded and the grommet attached. Remove the ventilator and place the new one on it with the folded edges under the flanges and the grommet properly positioned over the chain key slot. Use a blunt instrument or screen roller to roll the remaining two sides under the flanges. See caulking and installation instructions when re-installing the ventilator in the trailer.

### STOVE HOOD WITH BLOWER AND LIGHT—MODEL 9141 (110 Volt, 60 Cycle)—MODEL 9152 (12 Volt DC)———

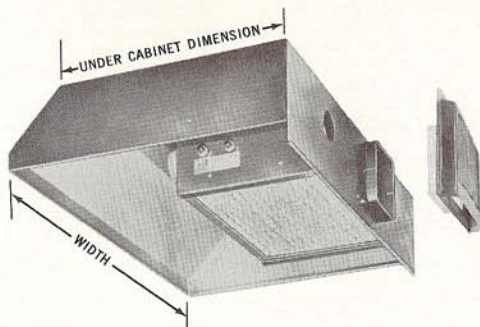

#### **INSTALLATION:**

Installation instructions are packaged with each canopy. Read these instructions carefully before attempting to install the canopy.

#### **SERVICE INSTRUCTIONS:**

##### **MOTOR REPLACEMENT**

Remove the filter and unplug the motor wire. Next, remove the three large screws from the motor mount and the motor and blower will drop out of the blower housing. A  $\frac{1}{8}$ " Allen wrench is required to loosen the set screw holding the blower to the motor shaft. Remove the blower and then the two nuts holding the motor to the support bracket. Re-assemble the new motor in the reverse manner of which it was disassembled.

#### **CLEANING OF THE FILTER AND BLOWER UNIT**

##### **FILTER**

At least once a month clean the filter in a hot water and detergent solution and rinse thoroughly.

##### **MOTOR AND BLOWER**

Remove the motor from the housing by removing the three screws holding the motor mount and disconnecting the electric supply cord, the motor and blower will then drop out of the blower housing. The blower can be removed from the motor by loosening the  $\frac{1}{8}$ " Allen screw in the blower. The blower can be washed in hot water and detergent. Do not use water on the motor, use a suitable electric motor cleaner. After the motor and blower have been cleaned and re-assembled, oil the motor with a few drops of S.A.E. #30 oil spouts provided on the motor.

**MODEL 950, SIDE WALL VENT, 115 VOLT A. C. (U. L. Listed as Model 427-L)**

**MODEL 9117, SIDE WALL VENT, 12 VOLT D. C.**

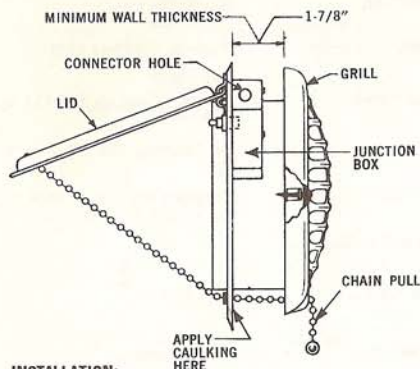

**INSTALLATION:**

**HOLE CUT-OUT**

Cut a hole 9½" square through the trailer sidewall.

**ELECTRIC SUPPLY**

It is suggested that the electric supply be brought into the hole cut-out from the bottom right hand side, facing the hole cut-out from the outside. Extend into the hole cut-out approximately 15" of the electric supply wire to facilitate connecting to the ventilator junction box.

**CAULKING**

Apply a suitable non-hardening type of caulking to the back side of the mounting flange as close to the outer edge of the flange as possible.

**INSTALLATION**

Remove the cover from the junction box and install a connector into the hole provided. Run the wiring, from the hole cut-out, through the connector into the junction box and complete the wiring connections to the switch and motor leads. Re-install the junction box cover. From the small package remove the length of bead chain and connect it to the chain attached to the ventilator lid. Place the venti-

lator into the hole cut-out, making sure that the hinge on the lid is at the top and the chain is hanging into the trailer. Fasten the ventilator to the trailer wall using #6 x ¾" steel cad-plated sheet metal screws. Remove the excess caulking from around the mounting flange and apply a suitable liquid sealer to the edge of the flange where it meets the trailer wall. Before fastening the inside grill to the ventilator, pass the ball on the end of the chain through the small hole and hook the chain in the key-way to hold it. Position the grill on the ventilator and fasten it with the screws provided from the package.

**SERVICE:**

**MOTOR CARE**

On the Model 950 sidewall ventilator oil spouts are provided at the front and rear of the motor for oiling. Oil the motor approximately every 3 months with a drop of S.A.E. 20 oil. Model 9117 is self oiled. For longer life of the motors, keep them wiped free of dirt and grease.

**MOTOR REPLACEMENT**

Remove the two screws holding the grill to the ventilator and release the bead chain so the grill can be removed completely. Before removing the junction box cover make sure the power supply to the ventilator has been disconnected. Remove the junction box cover and disconnect the leads coming from the motor. With a pair of pliers squeeze together the strain-relief holding the motor wires to the side of the ventilator and pull them out of the junction box. Remove the two nuts holding the motor to the bracket. At this point it would be best to have someone holding the motor from the outside so the motor will not drop and damage the fan blade. Re-install the new motor in the reverse procedure as outlined.

**SWITCH REPLACEMENT**

Remove the two screws holding the grill to the ventilator and release the bead chain so the grill can be removed completely. Before removing the junction box cover make sure the power supply to the ventilator has been disconnected. From the outside, with the lid wide open, remove the nut and washer holding the switch. Pull the switch and wires out of the junction box. Disconnect the wires to the old switch and install the new switch in the reverse procedure of above.

**HOW TO SELECT REPLACEMENT MOTORS AND FANS**

Find the "Model Number" or "Description" of the ventilator you have and order the replacement motor or fan by the corresponding number in the columns at right.

MODEL NUMBER	DESCRIPTION	MOTOR NO.	FAN NO.
926...	Power Vent Assembly (110 volt with switch)	011-105	011-108
931...	Power Vent Assembly (110 volt) UL approved	011-105	011-108
940...	Power Vent Assembly Kit (110 volt)	011-105	011-108
950...	Sidewall Vent (110 volt)	011-105	011-109
9110...	Power Vent Assembly (12 volt)	011-126	011-108
9117...	Sidewall Vent (12 volt)	011-126	011-128
9130...	Power Vent Assembly (12 volt)	011-126	011-108
9141...	Power Hood (110 volt)	011-133	
9152...	Power Hood (12 volt)	011-126	



The above parts are used in current models. If your parts are not listed or do not correspond with those shown, forward the broken parts to insure proper replacement.

## REPLACEMENT PARTS for HALL-MARK 1600 and 4600 SERIES JALOUSIE WINDOWS

When ordering replacement parts for Jalousie windows, include the Model No. located on the operator side near the bottom on the outside of the window.



In ordering seals and weather stripping, indicate the length of the old part plus 6" to cover any discrepancy.

PART NO.	DESCRIPTION	REMARKS
008-114	Operator, right or left	Replaces 1618 and 1619
008-171	Operator Handle	Handle for use on 008-114 operator.
002-201	Screw	For fastening 008-123 link to tilt bar.
013-157	Glass Holder	Designate left or right hand facing the outside of the window.
009-125	Glass Retainer Discs	
010-122	Weather Strip	Wool pile.
009-120	Glass Seal	Top and bottom.
009-144	Screen Spline	.130 dia.



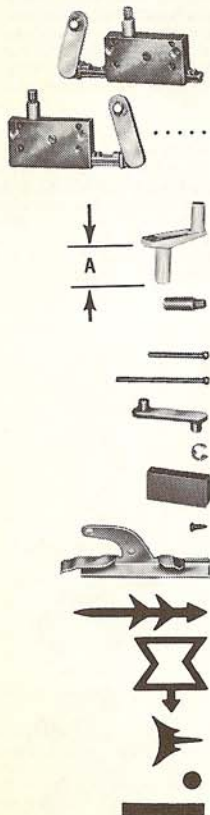







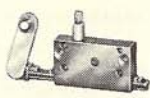

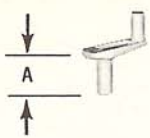





## REPLACEMENT PARTS for 2700 SERIES JALOUSIE WINDOWS

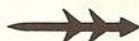

008-154	Rack Type Operator	Includes link and "E" ring.
008-169	Rack Type Operator	Windows with two (2) opening panes only.
008-170	Operator Handle	Plastic handle. "A" dimension is $1\frac{3}{4}$ "
008-188	Operator Handle	Plastic handle. "A" dimension is $1\frac{1}{4}$ "
008-189	Operator Handle	Plastic handle. "A" dimension is $\frac{1}{2}$ "
008-164	Extension	$\frac{7}{8}$ " extension for 008-154 & 008-169 operator.
002-219	Screw	$1\frac{3}{4}$ " screw for extension.
002-220	Screw	$2\frac{3}{4}$ " screw for extension.
008-173	Link Arm	For 008-154 operator.
007-117	"E" Ring	For holding link to operator and tilt bar.
009-211	Rack Support Block	
002-100	Screw	#6 x $\frac{3}{8}$ sheet metal mounting screw for rack support block.
013-143	Glass Holder	Designate left or right facing outside of window.
009-201	Top Seal	
009-202	Bottom Seal	
009-215	Side Seal	
009-144	Screen Spline	
009-107	Glass Seal	Used in stationary portion of combination windows.













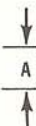
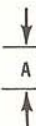



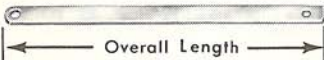

The above parts are used in current windows. If your parts are not listed or do not correspond with those shown, forward the broken parts to insure proper replacement.

SPARE PARTS for 2400 SERIES LITE-AIRE (WIDE LOUVER) WINDOWS

	PART NO.	DESCRIPTION	REMARKS
	008-154	.. Rack Type Operator	.. Includes link and "E" ring.
	008-165	.. Rack Type Operator	.. Window with single pane opening only.
	008-170	.. Operator Handle	.. Plastic handle. "A" dimension is $1\frac{5}{16}$ "
	008-188	.. Operator Handle	.. Plastic handle. "A" dimension is $1\frac{7}{16}$ "
	008-189	.. Operator Handle	.. Plastic handle. "A" dimension is $\frac{1}{2}$ "
	008-164	.. Extension	.. $\frac{7}{8}$ " extension for 008-154 & 008-165 operators.
	002-219	.. Screw	.. $1\frac{3}{4}$ " screw for 008-164 extension.
	002-220	.. Screw	.. $2\frac{3}{4}$ " screw for 008-164 extension.
	008-173	.. Link Arm	.. For 008-154 operator.
	007-117	.. "E" Ring	.. For holding link to operator and tilt bar.
	009-211	.. Rack Support Block	
	002-100	.. Screw	.. #6 x $\frac{3}{8}$ sheet metal screw for mounting rack support block.
	013-141	.. Glass Holder	.. Designate left or right hand facing the outside of the window.
	009-206	.. Clamping Pad	.. Used with 013-141 glass holder.
	2454	.. Horizontal Louver Glass Seal Assem.	.. Installed over top edge of louver glass — give length of old part.
	009-201	.. Top Seal	
	009-202	.. Bottom Seal	
	009-215	.. Side Seal	
	009-144	.. Screen Spline	
	009-107	.. Glass Seal	.. Used in stationary portion of combination windows.
	009-265	.. Rubber Pad	.. Same as 009-125 but thinner.

The above parts are used in current windows. If your parts are not listed or do not correspond with those shown, forward the broken parts to insure proper replacement.

REPLACEMENT PARTS for HALLMARK 3500 and 3600 MULTI-TORK WINDOWS

	PART NO.	DESCRIPTION	REMARKS
	008-167	Operator, Left Hand (shown)	Face the outside of the window to determine if the operator is a left or right hand.
	008-168	Operator, Right Hand	
	008-170	Operator Handle	Plastic handle. "A" dimension is 1 1/6"
	008-188	Operator Handle	Plastic handle. "A" dimension is 1 1/6"
	008-189	Operator Handle	Plastic handle. "A" dimension is 1/2"
	008-164	Extension	7/8" operator handle extension.
	002-219	Screw	1 3/4" extension screw.
	002-220	Screw	2 3/4" extension screw.
	3630	Link Assembly	Must give window model number and length of old part.
	007-117	"E" Ring	Holds link to torque arm and tilt bar.
	2647	Torque Arm	
	010-193	Torque Rod Support Bushing	
	010-182-1	Pivot Bracket	Designate left or right hand facing the outside of the window.
	009-248	Glass Seal	"U"-channel for vent assemblies.
	009-250	Top Seal	Fin type.
	009-251	Closing Seal	Lip type.
	009-144	Screen Spline	
	009-107	Glass Seal	Used in stationary portion of combination windows.
	009-253	Pivot Bar Support	
	009-268	Operator Support Block	

In ordering seals or spline, indicate the length of the old part plus 6" to cover any discrepancy.

The above parts are used in current windows. If your parts are not listed or do not correspond with those shown, forward the broken parts to insure proper replacement.



# REPLACEMENT PARTS for HALL-MARK 17 WINDOWS

Current operators in these sizes can be identified by this emblem on the knob.

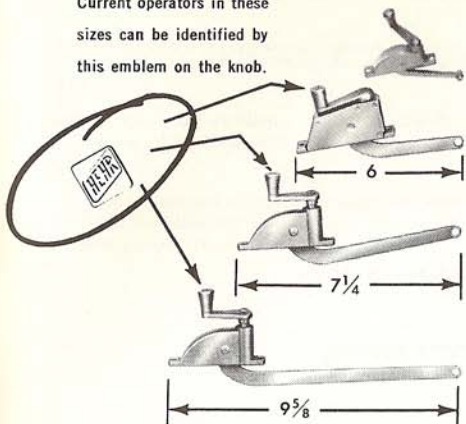









In ordering seals or spline, indicate the length of the old part plus 6" to cover any discrepancy.



When ordering replacement parts for HALL-MARK windows, include the Model No. located on the bottom outside of the window.







PART NO.	DESCRIPTION	REMARKS
008-124	...Gear Operator	6" window only. Give length of old part.
1796	...Gear Operator	...081 window only.
008-129	...Gear Operator	...Used on 11 3/8" windows.
008-131	...Gear Operator	...Used on 15 1/8" & 18 3/8" windows.
002-238	...Screw	...8-32 x 1/2" MS
008-200	...Handle	
007-106	...Screen Clip	...6" window only.
007-109	...Screen Clip	
009-137	...Glazing Bead	...Opening window section.
009-255	...Glazing Bead	...For 3/16" safety glass in vent section.
009-142	...Glazing Bead	...Stationary window section. 3/32" single strength or 1/8" double strength glass
009-177	...Glazing Bead	...3/16" glass
009-266	...Glazing Bead	...3/32" or 1/4" glass
009-144	...Screen Spline	...1/8" diameter.
009-145	...Plastic Hinge Stop	
009-146	...Closing Seal	...Hinge side only.
009-149	...Closing Seal	...Sides and bottom.
009-150	...Thermopane	Glazing Bead . Used with thermopane only.
009-139	...Ribbon Seal, 1/16" x 3/16"	...Stationary portion.
009-197	...Ribbon Seal, 1/16" x 1/4"	...Opening portion.
009-155	...Nylon Friction Pad	...1 req. per operator.
007-110	...Compression Spring	...1 req. per operator.
007-107	...Storm Sash Clips	...Opening portion.
007-108	...Storm Sash Clips	...Stationary portion.
1745	...Front Channel	...Give length of old part.
1770	...Back Channel	(Operator) . Give length of old part.

## REPLACEMENT PARTS for HALLMARK 2500 SLIDING WINDOWS

	PART NO.	DESCRIPTION	REMARKS
	010-177	Locking Handle	Designate left or right hand facing the outside of the window.
	1402	Catch	Mounts to stationary mullion, used with 010-177 locking handle.
	009-170	Nylon Glide	
	007-106	Screen Clip	
	010-183	Weatherstrip	Sliding vents.
	009-287	Glazing Bead	Opening section using $\frac{3}{32}$ " SSB or $\frac{1}{8}$ " DSB glass.
	009-178	Glazing Bead	Opening section using $\frac{3}{16}$ " crystal or safety glass.
	009-144	Screen Spline	
	009-107	Glass Seal	Stationary portion.

In ordering seals or spline, indicate the length of the old part plus 6" to cover any discrepancy.

## REPLACEMENT PARTS for HALL-MARK STORM SASH

	PART NO.	DESCRIPTION	REMARKS
	009-129	Glass Seal	Give length required plus 6".
	009-168	Back Seal	Give length required plus 6".
	010-124	Retainer Clip	Shoulder height $\frac{5}{16}$ ".
	009-212-2	Molded Gold Nylon Storm Sash Clip	Used on gold and wood inner frame.
	002-136	Gold Screw	No. 6 x $\frac{1}{2}$ " SMS
	010-163	Retainer Clip, $\frac{7}{16}$ " Shoulder	Spring loaded; used on removable screens.

The above parts are used in current windows. If your parts are not listed or do not correspond with those shown, forward the broken parts to insure proper replacement.

**REPLACEMENT PARTS for STANDARD WINDOWS**

PART NO. DESCRIPTION REMARKS

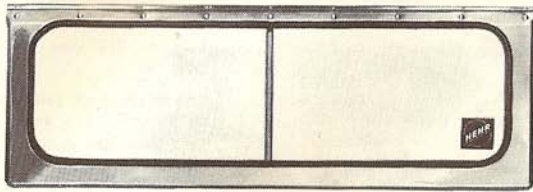

Pane Assembly... ..When ordering give type of window and outside dimensions, height x width and which pane is required (top, center or bottom). Lever operated shown. Please specify if the pane is lever or gear operated.

**LEVER OPERATOR PARTS** .....

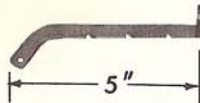

606 .... ..Lever ..... ..For model 9" & 11" AF French windows.

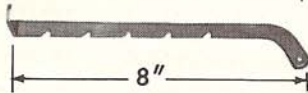

607 .... ..Lever ..... ..For model 14" A & AF windows.

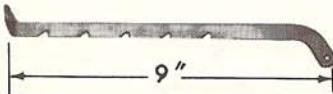

608 .... ..Lever ..... ..For model 18" A & AF windows.

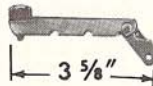

611 .... ..Lever ..... ..Used on 618 Vent window only.

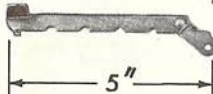

612 .... ..Lever ..... ..Used on 9" Single Pane "A" windows, only when the lever slot is at the top of the window. If it is not, use the 614 Lever.

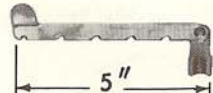

613 .... ..Link Lever..... ..Used on top pane only of Dual Pane and Tri-pane windows.



614 .... ..Link Lever..... ..Used on model 9" A & 11" A Single Pane windows, bottom pane on Dual Pane windows and center and bottom pane on Tri-pane windows.

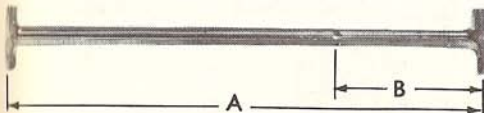

141 .... ..Front Channel... ..Give A and B dimension of old part.













241 .... ..Back Channel... ..Give length of old part and type of window, Single Pane, Dual Pane, Tri-pane, etc. This channel has been discontinued on the 18" Single Pane "A" window and will be replaced by Part Nos. 237-18, 619, & 608.

# REPLACEMENT PARTS for STANDARD WINDOWS

## LEVER OPERATOR PARTS (Continued)

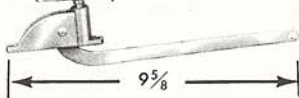
PART NO.	DESCRIPTION	REMARKS
 242-6	Back Channel	Used on 618 Vent window only.
 238	Back Channel	Give length of old part. Used on 9", 11", 14" and 18" "A" and "AF" windows.
 007-100	Spring	
 272	Spring Lock Grommet	
 618	Short Hook	6 $\frac{1}{8}$ " long.
 619	Long Hook	9 $\frac{1}{8}$ " long.
 271	Window Grommet	







## GEAR OPERATOR PARTS

PART NO.	DESCRIPTION	REMARKS
 142	Front Channel	Give length of old part. (Used with 008-131 and 008-132 operators.)
 143	Front Channel	Give length of old part. (Used with 010-100 locking handle.)
 255	Operator Back Channel	Give length of old part and type of window. (Dual, tri, four pane, etc.) Used with 008-132 operator.
 250	Latch Back Channel	Give length of old part and type of window. (Dual, tri, four pane, etc.) Used with 010-100 locking handle.
 254	Operator Back Channel	Give length of old part. Used on 9", 11", 14" & 18" A and AF single pane windows with 008-131 or 008-132 operators.
 249	Latch Back Channel	Give length of old part. Used on 9", 11", 14" and 18" A and AF single pane windows with 010-100 locking handles.
 008-132	Operator	Used on 9" and 11" A and AF single pane windows. Also on dual, tri 4-pane tiered windows.
 008-131	Operator	Used on 14" and 18" A and AF single pane windows.
 008-200	Handle	
 002-238	Screw	8-32 x 1/2" MS
 008-101	Operator	Used on 618 vent window only.

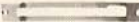

To make sure that this is the operator you want, check your broken operator for this emblem on the knob. If it does not have this emblem send in the old operator.

## REPLACEMENT PARTS for STANDARD WINDOWS

### GEAR OPERATOR PARTS (Continued)



	010-100 . . . Locking Handle . . .	Used on 249 and 250 back channels.
	275 . . . . . Grommet . . . . .	Used on 250 flared channels (attaching 010-100 locking handles.)
	273 . . . . . Grommet . . . . .	Used on 618 vent window only.
	009-114. . . Nylon Roller . . . .	Used with 008-101 operator only.
	009-173. . . Nylon Friction Pads . . . . .	Used with 008-131 and 008-132 operators.
	007-110. . . Compression Spring . . . . .	Used with 008-131 and 008-132 operators.

### GASKETS & SEALS USED IN ALL STANDARD WINDOWS



	009-101. . . Standard Backframe Gasket	In ordering gaskets or seals, indicate the length of the old part plus 6 inches to cover any discrepancy.
	009-100. . . Standard Center Gasket	
	009-111. . . Standard Glass Seal	

The above parts are used in current windows. If your parts are not listed or do not correspond with those shown, forward the broken parts to insure proper replacement.

### REPLACEMENT PARTS for LPG COMPARTMENTS

	PART NO.	DESCRIPTION
	010-100	Locking Handle
	761	Catch

### REPLACEMENT LOCKS for BAGGAGE DOORS

	PART NO.	DESCRIPTION	REMARKS
	010-102	Baggage Door Lock —Clip On . . . . . Straight Cam	} Will fit .030 and .040 material thickness only.
	010-202	Baggage Door Lock —Clip On . . . . . Offset Cam	

REPLACEMENT PARTS for MODELS 900 and 9171-14-14 LITE-AIRE NO DRAFT ROOF VENTS

PART NO.	DESCRIPTION	REMARKS
901	Lid and Operator Assembly	It is recommended that this assembly be replaced or sent in to the factory for repair rather than ordering the individual parts.
008-100	Operators with Knobs	
008-100K	Operator Knobs	
903	Vent Screen	
9170	Lid Assembly	
942	Power Vent Kit Screen	

REPLACEMENT PARTS for 9153-17-17 LITE-AIRE NO DRAFT ROOF VENTS

PART NO.	DESCRIPTION	REMARKS
9157	Lid Assembly	
9156	Base Mounting Frame Assembly	
9154	Screen Frame Assembly	
009-144	Screen Spline	
008-100	Operator with Knobs	
008-100K	Operator Knobs	
9165	Transit Lid	

The above parts are used in current ventilators. If your parts are not listed or do not correspond with those shown, forward the broken parts to insure proper replacement.

REPLACEMENT PARTS for STANDARD ROOF VENTS MODEL 979 and 9192

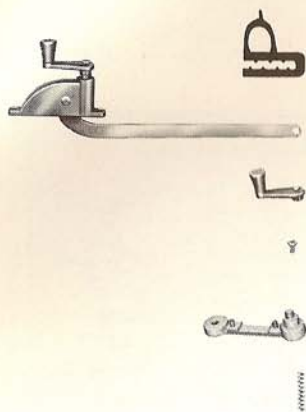

PART NO.	DESCRIPTION	REMARKS
009-130	Std. Vent Seal	
008-131	Operator	
008-200	Handle	
002-238	Screw	8-32 x 1/2" MS
009-155	Nylon Friction Pads	Used with 008-131 operator.
007-110	Compression Spring	Used with 008-131 operator.

REPLACEMENT PARTS for JR. VENT MODEL 9108

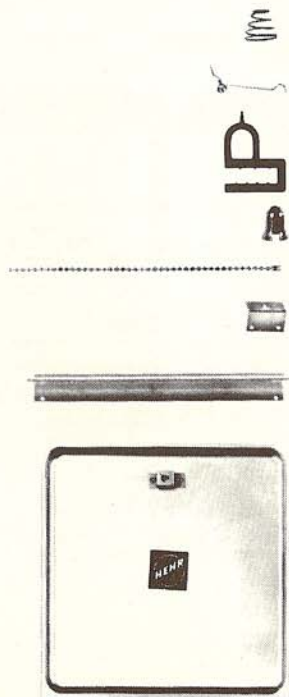

PART NO.	DESCRIPTION	REMARKS
007-102	Compression Spring	Used on end of chain in lid.
007-115	Lid Spring	R & L reg. left hand shown.
009-130	Vent Seal	
010-105	Large Chain Pendant	
010-130	10" Chain with Small Pendant	
9103	Chain Catch	
9104	Hinge	
9107	Lid Assembly	

The above parts are used in current ventilators. If your parts are not listed or do not correspond with those shown, forward the broken parts to insure proper replacement.

## REPLACEMENT PARTS for 9141 AND 9152 STOVE HOODS



PART NO.	DESCRIPTION	REMARKS
011-133	Motor	110-volt, 60 cycle for 9141.



011-126	Motor	12-volt, for 9152.
---------	-------	--------------------



010-165	Filter pad	
---------	------------	--



011-129	Switch	
---------	--------	--



011-131	Fixture Receptacle	
---------	--------------------	--

## EXHAUST OUTLETS for STOVE HOODS



PART NO.	DESCRIPTION	REMARKS
410	Exterior Mount for 3700 Series	Outlet size 2 1/8" x 6 7/8"



415	Exterior Mount for 9141-9150-9152	Outlet size 3 3/8" x 3 3/8"
-----	-----------------------------------	-----------------------------

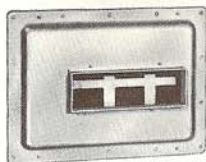

420	Flush Mount for 3700 Series	Outlet size 2 1/8" x 6 7/8"
-----	-----------------------------	-----------------------------



425	Flush Mount for 9141-9150-9152	Outlet size 3 3/8" x 3 3/8"
-----	--------------------------------	-----------------------------

The above parts are used in current models. If your parts are not listed or do not correspond with those shown, forward the broken parts to insure proper replacement.



REPLACEMENT PARTS for MODEL 950 SIDE WALL VENTILATOR

PART NO. DESCRIPTION REMARKS



956A . . . Lid Assembly . . . . . For vents with 7 3/4" blade



010-130 . . . 10" Ball Chain Only

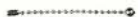

010-131 . . . 4" Ball Chain Only



013-121 . . . Hinge (Lid)



013-122 . . . Painted Grill  
Assembly . . . . . Designate color

013-118 . . . Unpainted Grill  
Assembly









007-101 . . . Torsion Spring . . . Designate left or right hand  
(Lid) . . . . . facing outside of vent

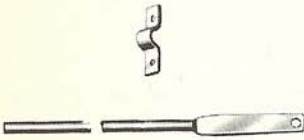
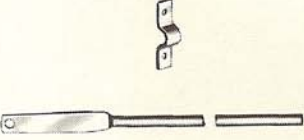

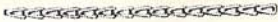
011-101 . . . Switch

REPLACEMENT PARTS for 3200 SERIES TRUNK DOOR

PART NO.	DESCRIPTION	REMARKS
	010-196 ... Three point lock assembly	
	002-121 ... Screw ..... No. 6 x 1/2" SMS for installation of 3 point lock	
	010-197 ... Locking handle .... 2 screws included	
	010-198 ... Cam Plate	
	010-199 ... Chain ..... Give number of feet required	
	009-284 ... Seal ..... Give length required plus 6"	
	002-320 ... Tinnerman Nut	
	002-325 ... Tee Nut	

When ordering replacement parts for trunk doors, include the Model No. located outside on the bottom frame.

## CONTROL OF CONDENSATION

Moisture condensation on the windows of a mobile home is not caused by the materials used in the windows. It is the result of too much moisture in room air, and it is an indication that good, weather-tight construction is preventing escape of excess moisture into the outside air.

The problem can be controlled only by regulating interior relative humidity. Relative humidity is the ratio between the amount of water vapor present in the air and the greatest amount of vapor the air could contain at the same temperature. If windows do not fog in cold weather it is evident that room air is not saturated with moisture. In other words, the relative humidity is satisfactorily low and condensation does not take place.

However, normal daily living activities can add an astonishing amount of moisture. For example, baths and showers contribute about a half-pint of moisture to the air in mobile home rooms. Washing dishes produces a similar addition to interior humidity. Mopping the floor burdens room atmosphere with the vapor from approximately two pints of water. Boiling foods adds the equivalent of two and one half pints of water to the air. Studies show that a family of four will pour from fifteen to twenty gallons of water a week into the household air.

Here is what happens when the relative humidity is thus increased by ordinary living. Cold air cannot carry as high a percentage of moisture as can warm air. When outdoor temperatures are low, windows and other exterior surfaces are cooler than the interior air. When the moist warm air comes into contact with these cooler surfaces its temperature is lowered and the moisture it cannot further carry is deposited in the form of droplets on the colder surfaces.

Heating authorities tell us that indoor relative humidity in cold weather should never exceed forty percent. As outside temperature falls, the indoor humidity level should be lowered if condensation is to be avoided. Following is a table of desirable maximum humidities. (Use of a good hygrometer is recommended as an aid in keeping relative humidity balanced.)

Outside Air Temperature	Inside Relative Humidity for 70°F. Inside Air Temperature
-20°F. or below	not over 15%
-20°F. to -10°	not over 20%
-10°F. to 0°	not over 25%
0°F. to 10°	not over 30%
10°F. to 20°	not over 35%
20°F. to 40°	not over 40%

Observance of the following suggestions will aid in controlling condensation:

1. Keep room temperature at not more than 72° to 75°F.
2. Regularly bring in a reasonable amount of dry outside air by controlling the fresh air intake of your furnace.
3. Use exhaust fans and ventilators when cooking, bathing, washing dishes, etc.
4. Do not run excessively hot water in sink or bathroom.
5. Assure proper ventilation by use of sidewall ventilators.
6. Use one of the small dehumidifiers now available for mobile homes.



**HEHR MFG. CO.**  
3333 Casitas Avenue  
Los Angeles  
California 90039

**HEHR MFG. CO.**  
708 Industrial Road  
Nampa  
Idaho 83651

**HEHR MFG. INC.**  
1103 West Pearl Street  
Chesaning  
Michigan 48616

**HEHR PRODUCTS CORP.**  
2461 Third Avenue  
Cochran Field  
Macon  
Georgia 31201

**HEHR MIDWEST**  
Highway 81 and 24th Street  
Newton  
Kansas 67114

**HEHR MFG. CO.**  
Lincoln Road  
Orwigsburg  
Pennsylvania 17961

**Installation and service instructions  
including spare parts lists for  
current Hehr vents and windows**

